

L1/L2GHNRRKIT

Hangar Networked Re-Radiating Kit Technical Product Data

Features

- High Gain Amplified Roof Antenna
 - Provides 40 dB gain via internal LNA.
- Re-Radiating Amplifier with External Power Supply
 - 30 dB gain typical.
- Optional Kit Mounting Hardware
 - Roof Antenna Mount & Re-Radiating Amplifier Mount available.
- Optional Re-Radiating Variable Gain Amplifier
 - Adjustable gain from 1 dB to 30 dB.



Please note that the pictured L1RAMB (active antenna mount), cable and WRUMT (passive antenna mount) are not included with the L1/L2GHNRRKIT and are sold separately.

Description

The GPS Hangar Networked Re-Radiating Kit (L1/L2GHNRRKIT) comes with the components to build a re-radiating system that can re-radiate all the major GNSS frequencies indoors. The GNSS signals received by the roof antenna are amplified and re-radiated to GPS receivers indoors, eliminating the need to attach receivers directly to the roof antenna. The L1/L2GHNRRKIT consists of an active roof antenna, a passive re-radiating antenna, and a re-radiating amplifier (L1/L2GHNRRKAMP) with an external power supply that powers the entire system. A cable from the roof antenna to the re-radiating kit is required and can be purchased separately. With up to 150ft of LMR400 low loss coax cable connecting the roof antenna to the re-radiating amplifier, the L1/L2GHNRRKIT will transmit GNSS signals indoors to receivers up to 100 feet away.

In the standard Networked (Externally Powered) configuration, the re-radiating amplifier output (J1) is DC Blocked. Custom gain, DC power, and connector configurations are available upon request.

Use Cases

- To re-radiate signal indoors for GPS product testing.
- To maintain GPS signal for emergency vehicles parked indoors.
- To facilitate faster GPS signal acquisition for aircraft inside a hangar.
- In combination with one of our splitter devices to create a GPS distribution network.

L1/L2GHNRRKIT

Roof Antenna Electrical Specifications, TA=25°C

Parameter	Notes	Min	Typ	Max	Unit
Frequency	Receives and amplifies all major GNSS constellations.	1500 1150		1615 1290	MHz
Axial Ratio	Ratio between the major and minor axes of the polarization ellipse.			2.5	dB
Gain	The relative increase in signal power provided by the internal LNA.	35	40	45	dB
GPS L1 Bandwidth	Passband centered at GPS L1 frequency.		115		MHz
GPS L2/L5 Bandwidth	Passband centered at GPS L2/L5 frequency.		140		MHz
Filtering	Out of band rejection +/-50MHz from band-edge	-30	-45	>80	dB
Noise Figure	The increase in noise power relative to an ideal amplifier.		3.0		dB
Output SWR	Output Standing Wave Ratio: S22 over the passband.		2.0:1		-
Characteristic Impedance	Output port matched to 50Ω.		50		Ω
Req. DC Input V.	Operating Voltage Range.	2.5		12.0	VDC
Current Draw	Typical current consumption.		37	50	mA
Polarization					
Right Hand Circular Polarization					
Connector Options	Connector Style	Charge			
	Type TNC-female	No Charge			

Re-Radiating Antenna Electrical Specifications, TA=25°C

Parameter	Notes	Min	Typ	Max	Unit
Frequency	Re-Radiates all major GNSS frequencies.	1500 1150		1615 1290	MHz
Axial Ratio	Ratio between the major and minor axes of the polarization ellipse.			2.5	dB
Peak Gain	The Increase in signal power relative to an isotropic antenna source.	3			dBic
GPS L1 Bandwidth	Passband centered at GPS L1 frequency.		115		MHz
GPS L2/L5 Bandwidth	Passband centered at GPS L2/L5 frequency.		140		MHz
Input SWR	Input Standing Wave Ratio: S11 over the passband.		2.0:1		-
Characteristic Impedance	Input port matched to 50Ω.		50		Ω
Polarization					
Right Hand Circular Polarization					
Connector Options	Connector Style	Charge			
	Type TNC-female	No Charge			

L1/L2GHNRRKIT

Re-Radiating Amplifier Electrical Specifications, TA=25°C

General Specification

Parameter	Notes	Min	Typ	Max	Unit
Frequency Range	Covers all major GNSS constellations.	1.1		1.7	GHz
Characteristic Impedance	Input and output ports matched to 50Ω.		50		Ω
Req. DC Input V.	Operating Voltage Range.	3.3		15	VDC
Current Draw	Typical current consumption.		36	40	mA

GPS L1 & L2 RF Specification ⁽¹⁾

Parameter	Notes	Min	Typ	Max	Unit
Gain	The relative increase in signal power provided by the amplifier.	29	30	31	dB
Input SWR	Input Standing Wave Ratio: S11			2.0:1	-
Output SWR	Output Standing Wave Ratio: S22			2.0:1	-
Noise Figure	The increase in noise power relative to an ideal amplifier.		L1:2.00 L2:4.25		dB
Band Gain Flatness	The difference in loss or gain between the L1 and L2 frequencies.		0.5	1.0	dB
Group Delay	The transmit time for the signal passing through the device.		L1:1.5 L2:2.1		ns
Reverse Isolation	Attenuation applied signals traveling backwards through the amplifier: S12.		L1: -55 L2: -60		dB
Input P1dB	The 1dB compression point.		L1: -21.5 L2: -23.0		dBm
3rd Order Intercept	Third-order intercept point at L1.		-14		dBm

(1): Performance is slightly reduced around GPS L5. If working on sensitive L5 applications, please request performance data.

External Power Options (Networked Option)		
Source Voltage Options	Voltage Input	Style
	110VAC	Transformer (ITA Type A Wall Mount)
	220VAC	Transformer (ITA Type C Wall Mount)
	240VAC (United Kingdom)	Transformer (ITA Type G Wall Mount)
	Customer Supplied DC 9-32 VDC	MIL-DTL-5015 10SL Two-Pin DC Connector (Includes Mate)
Output Voltage Options ⁽²⁾	DC Voltage Out	Max Current out For Corresponding Vout
	3.3 V	110mA
	5V	130mA
	9V	140mA
	12V	180mA
	15V	220mA
	Custom	Custom
Standard DC Configuration without External Power Option		
All Ports Pass DC		
Standard DC Configuration with any External Power Option (AC/DC or Military DC)		
J1 Port DC Blocked with 200Ω load standard		
Antenna Port is DC Pass		
Connector Options	Connector Style	Charge
	Type N-female	No Charge
	Type SMA-female	No Charge
	Type TNC-female	No Charge
	Type BNC-female	No Charge
	Other	Contact GPS Networking

(2): With Network Option, any RF port (input or output) can be specified to Pass DC or Block DC

L1/L2GHNRRKIT

Part Number Configuration

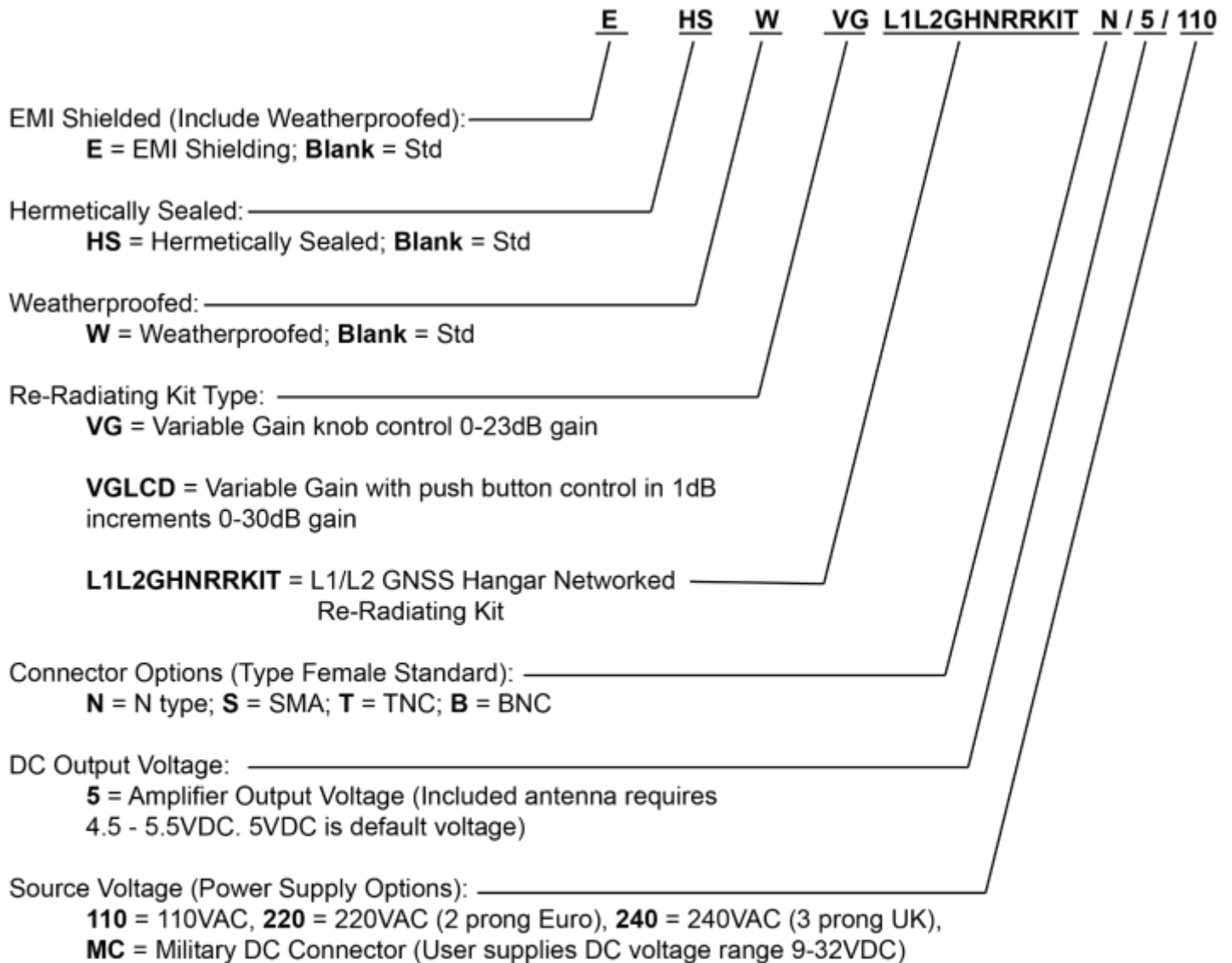

(Military DC Mating Connector is included standard with the MC power option).

When no external power supply option (AC or DC) is selected, Output 1/J1 is Pass DC Standard.

When external power supply option is selected, all outputs are DC blocked standard.

Contact GPS Networking Technical Support at 1-800-463-3063 or salestech@gpsnetworking.com for any questions regarding non-standard configurations and corresponding part numbers.

L1/L2GHNRRKIT

Performance

L1/L2GHNRRKAMP (Standard Gain)

Each L1/L2GHNRRKAMP ships with a test sheet that verifies critical performance characteristics, such as gain, input VSWR, and amplitude balance; a typical VNA test sheet is shown below

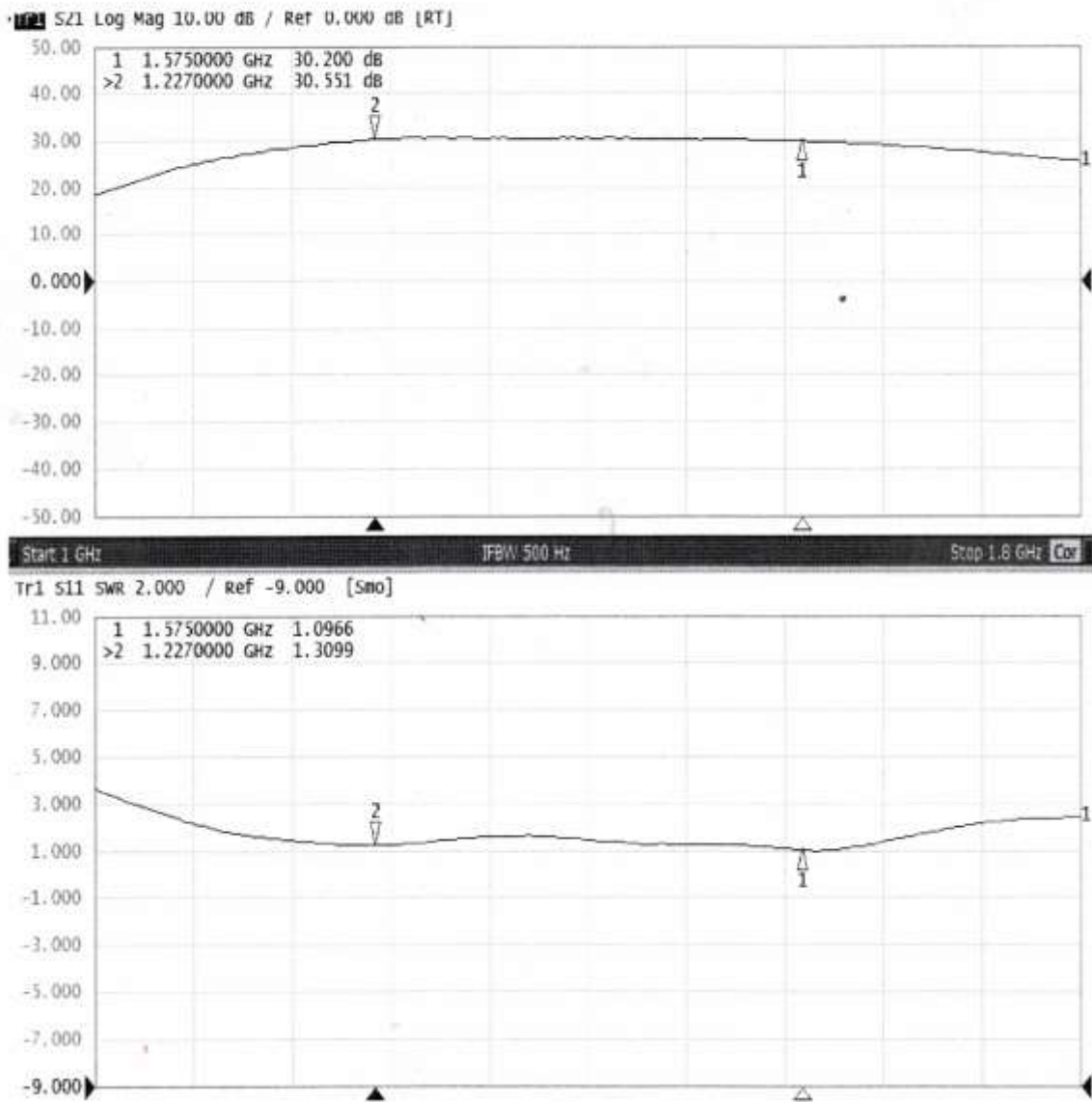
Mechanical

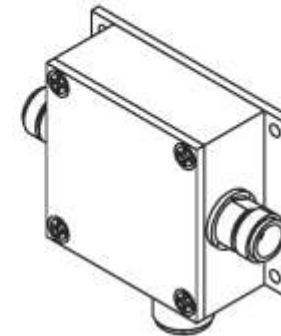
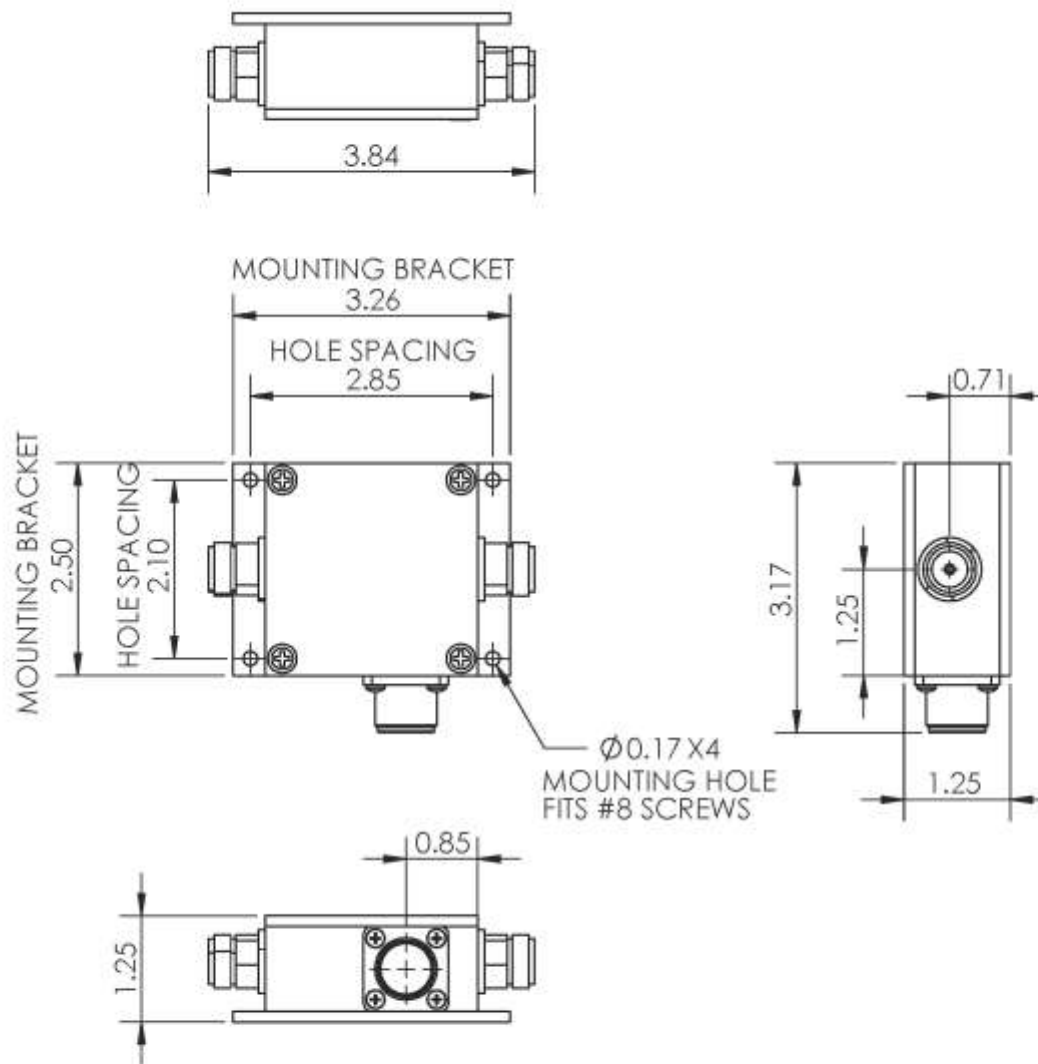

Mechanical Dimensions:
 Depth: 1.3"
 Width: Body: 2.5"
 Baseplate: 3.25"
 Height: 2.5"
 Dimensions listed above do not include connectors
 Weight: 9.6oz (272g) MAX
 Maximum weight is with female N-connector option
 Weight will vary by connector type
 Operating Temperature Range: -57°C to +87°C
 Housing and Baseplate Finish: Electroless Nickel Plated (MIL-C-26074C, Class 1) 0.0001-0.0003 MAX
 Lid Finish: Anodize, Type II, Class 2, Black, per MIL-A-8625

Female N connectors shown, other options available
 MC - Military DC connector shown, other options available
 EMI shielding may increase dimension by 0.02 inches per axis



373 E. Industrial Blvd.
 Pueblo West, CO 81007

HNRKAMP-N/5/MC

Hangar Networked Re-Radiating Kit Amplifier

Tolerances:
 X ± 0.030
 XX ± 0.015
 XXX ± 0.005
 Angle ± 1°

12-21-2020

NW

Scale: 1:2

Rev: 1

Sheet 1 of 1

Units are inches and degrees



Contact NavtechGPS for product details. www.NavtechGPS.com
 +1-703-256-8900 • 800-628-0885 • info@navtechgps.com

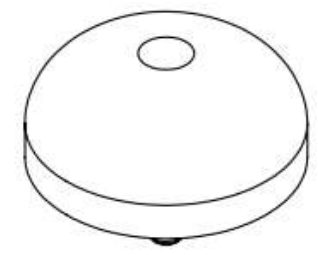
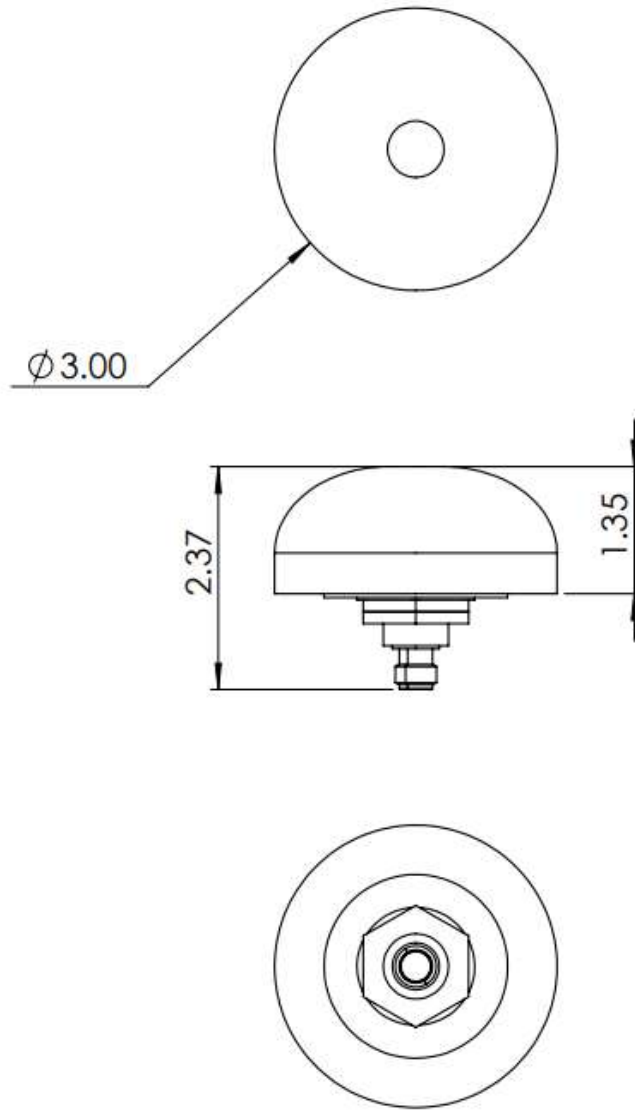

Mechanical
 Dimensions:
 Diameter: 3.0"
 Height: 1.4"
 Weight: 7.4oz (210g) MAX
 Environmental Rating: AAR
 Compliant
 IP Rating: IP 67

Female TNC connector required, use adapter for mating

 373 E. Industrial Blvd. Pueblo West, CO 81007	L1/L2GRRKPA-T				Tolerances: X \pm 0.030 XX \pm 0.015 XXX \pm 0.005 Angle \pm 1°
	Multi GNSS Passive High Performance Antenna				
1-8-2021	NW	Scale: 1:2	Rev: 1	Sheet 1 of 1	Units are inches and degrees

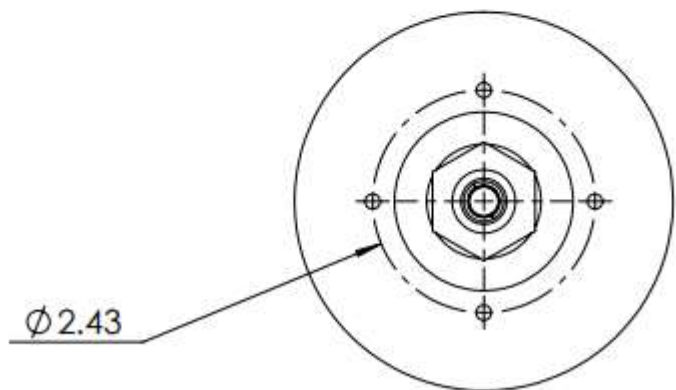
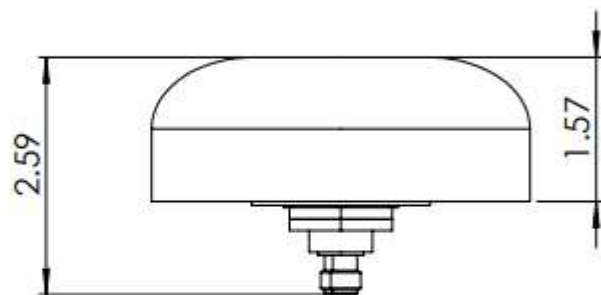
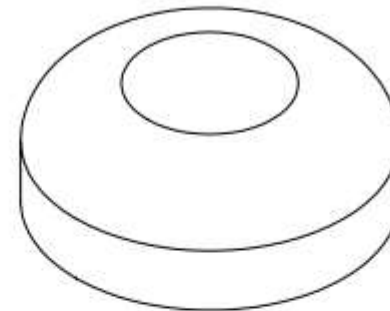
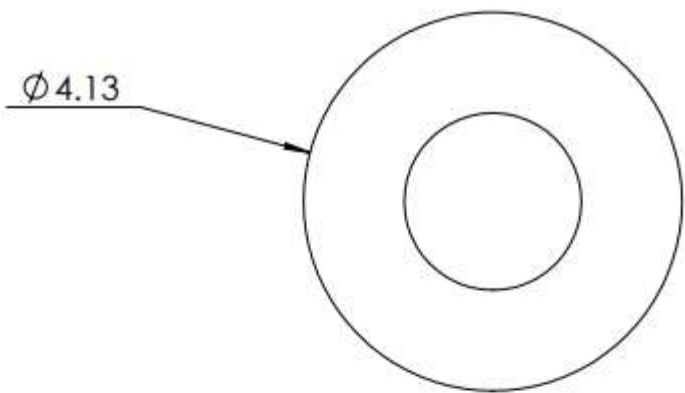

Mechanical
 Dimensions:
 Diameter: 4.13"
 Height: 1.57"
 Weight: 13.6oz (386g) MAX
 Environmental Rating: AAR
 Compliant
 IP Rating: IP 67

Female TNC connector required, use adapter for mating

 373 E. Industrial Blvd. Pueblo West, CO 81007	L1/L2GPSA-T				Tolerances: X ± 0.030 XX ± 0.015 XXX ± 0.005 Angle ± 1°
	Multi GNSS High Performance Antenna				
1-8-2021	NW	Scale: 1:2	Rev: 1	Sheet 1 of 1	Units are inches and degrees