



R330

User Guide

Part No. 875-0339-0 Rev A1

Hemisphere
GPS

This device complies with part 15 of the FCC Rules. Operation is subject to the following two conditions:

- (1) This device may not cause harmful interference, and
- (2) this device must accept any interference received, including interference that may cause undesired operation.

Copyright Notice

Copyright Hemisphere GNSS, Inc. (2013). All rights reserved.

No part of this manual may be reproduced, transmitted, transcribed, stored in a retrieval system or translated into any language or computer language, in any form or by any means, electronic, mechanical, magnetic, optical, chemical, manual or otherwise, without the prior written permission of Hemisphere GNSS.

Trademarks

Hemisphere GPS[®], the Hemisphere GPS logo, COAST[™], Crescent[®], Earthworks[®], Eclipse[™], e-Dif[®], L-Dif[™], miniEclipse[™], PocketMAX PC[™], PocketMAX[™], PocketMax3[™], S320[™], SBX-4[™], SureTrack[®], Vector[™], XF1[™], and XF2[™] are proprietary trademarks of Hemisphere GNSS, Inc. Other trademarks are the properties of their respective owners.

Patents

Hemisphere GNSS products may be covered by one or more of the following patents:

U.S. Patents				Australia Patents	
6111549	6876920	7400956	8000381	8214111	2002244539
6397147	7142956	7429952	8018376	8217833	2002325645
6469663	7162348	7437230	8085196	8265826	2004320401
6501346	7277792	7460942	8102325	8271194	
6539303	7292185	7689354	8138970	8307535	
6549091	7292186	7808428	8140223	8311696	
6711501	7373231	7835832	8174437	8334804	
6744404	7388539	7885745	8184050	RE41358	
6865465	7400294	7948769	8190337		

Other U.S. and foreign patents pending.

Notice to Customers

Contact your local dealer for technical assistance. To find the authorized dealer near you:

Hemisphere GNSS, Inc.
8444 N 90th St, Suite 120
Scottsdale, AZ 85258 USA
Phone: (480) 348-9919
Fax: (480) 348-6370
precision@hemispheregps.com
www.hemispheregps.com

Technical Support

If you need to contact Hemisphere GNSS Technical Support:

Hemisphere GNSS, Inc.
8444 N 90th St, Suite 120
Scottsdale, AZ 85258 USA
Phone: (480) 348-9919
Fax: (480) 348-6370
techsupport@hemispheregps.com

Documentation Feedback

Hemisphere GNSS is committed to the quality and continuous improvement of our products and services. We urge you to provide Hemisphere GNSS with any feedback regarding this guide by writing to the following email address: techsupport@hemispheregps.com.

Contents

Chapter 1	Introduction	1
	What's In This Guide?	2
	Product Overview	2
	Key Features	3
	What's Included in Your Kit	3
	Using PocketMax to Communicate with the R330	4
Chapter 2	Installing the R330	5
	Mounting the Receiver	6
	Mounting the Antenna	8
	Magnetic Mount	8
	Pole Mount	8
	Surface Mount	9
	Routing and Connecting the Cables	9
	Connecting the Receiver to External Devices	10
	Default Parameters	11
Chapter 3	Operating the R330	13
	Powering the Receiver On/Off	14
	Status LED Indicators	15
	Startup	16
	Menu System Overview	17
	Menu Display	17
	Navigating the Menus	17
	Menu and Menu Item Selection in This User Guide	18
	Configuring the R330	19
	Config Wizard Menu	19
	Using the Config Wizard	20
	USB Data Logging	21
	Selecting the Data File Type and Log Options	22
	Logging Data to a File	23
	Data Post-Processing	24
Chapter 4	RTK	25
	Installing the Base Station	26
	Installing the Rover Radio	26
	Using the R330 as a Base Station or Rover	27
	Setting Up the R330 as a Base Station	27
	Setting Up the R330 as a Rover	28
	Connecting the R330 to a Base/Rover Radio	29

	RTK Operation	29
Appendix A	Troubleshooting	31
Appendix B	Menu Map	33
	GNSS Menu	35
	Differential Menu	36
	Base Station Menu	39
	Config Wizard Menu	39
	System Setup Menu	40
	Data Logging Menu	41
Appendix C	Technical Specifications	43
Index		47
End User License Agreement		49
Warranty Notice		52



Chapter 1: Introduction

What's In This Guide?

Product Overview

Key Features

What's Included in Your Kit

Using PocketMax to Communicate with the R330

What's In This Guide?

This user guide provides the following information to get you up and running quickly with your R330™ GNSS receiver.

- This chapter briefly describes the R330 and the parts in your R330 kit.
- Chapter 2, “Installing the R330” describes how to mount the receiver and antenna, connect the cables, connect the receiver to external devices, and configure the receiver.
- Chapter 3, “Operating the R330” provides instructions on powering the receiver and using the LED indicators and menu system.
- Appendix A, “Troubleshooting” provides possible solutions for issues.
- Appendix B, “Menu Map” provides a full map of all system menus.
- Appendix C, “Technical Specifications” lists the technical specifications of the R330.

Note: Throughout the rest of this user guide the R330 GNSS receiver is referred to simply as the R330.

Product Overview

The R330 is a multi-GNSS RTK, high accuracy GNSS receiver that allows you to complete your work quickly and accurately. Built on Hemisphere GPS' Eclipse™ platform, R330 boasts the latest GNSS patented technology and offers extremely quick startup and reacquisition times.

The standard model R330 tracks L1 GPS and L1 GLONASS and via subscriptions can track L1/L2 GPS, SBAS, beacon, and L-band DGNSS/HP/XP DGPS and high precision signals. R330 supports raw data logging to a removable USB flash drive for post processing.

You can upgrade your R330 by adding RTK6 base station functionality or RTK rover performance, as well as GLONASS tracking for a cost effective, multi-GNSS solution compatible with other GNSS products.

RTK performance is scalable on the R330. Utilize the same centimeter-level accuracy with L1/L2 GPS, or improve performance and reliability with L1/L2 GNSS signals. Hemisphere's exclusive SureTrack® technology gives peace of mind knowing the RTK rover is making use of every satellite it is tracking, even satellites not tracked at the base. Benefit from fewer RTK dropouts in congested environments, faster reacquisitions and more robust solutions due to better cycle slip detection. SureTrack also removes concerns with using various manufacturers GNSS base. Even if the GNSS base delivers L1/L2 GPS, SureTrack with GLONASS at the rover will deliver RTK performance where others cannot.



The R330 receiver, with its display and user interface, can be conveniently installed near the operator, while the included antenna can be installed elsewhere.

R330 also features Hemisphere GPS' exclusive COAST™ technology that enables Hemisphere GPS receivers to utilize aging differential GPS correction data for 40 minutes or more without significantly affecting positioning quality. R330 is less likely to be affected by differential signal outages due to signal blockages, weak signals, or interference when using COAST.

Key Features

Key features of the R330 include:

- High-precision positioning in RTK, L1/L2, SBAS, beacon, and L-band
- SureTrack technology improves RTK performance, especially with optional GLONASS tracking
- Long-range RTK baselines of up to 50 km
- COAST technology maintains accurate solutions for 40 minutes or more after loss of DGPS or SBAS signal
- Uses standard USB flash drive for data logging
- Status LEDs and menu system make R330 easy to monitor and configure
- Integrated L-band DGNSS/HP/XP tracking powers down when not in use
- SBAS satellite ranging technology increases the number of satellites in view for greater RTK reliability
- Fast update rate of up to 20 Hz providing the best guidance and machine control

What's Included in Your Kit

Table 1-1 lists the parts included in your R330 kit. Review the parts shipped with your kit: if any parts are damaged, contact your freight carrier. If any parts are missing, contact your dealer.

Note: The R330 requires an antenna; the antenna, antenna cable, and any related antenna mounting hardware are purchased separately.

Table 1-1: Parts list

Item	Description	Qty	Part Number
A	R330 GNSS receiver	1	803-0065-000#
B	Receiver mounting kit (two brackets and related hardware)	1	710-0056-000#
C	Power cable, circular, 3 m	1	054-0146-000#
D	Data cable, DB-9 female to DB-9 male, 3 m	1	050-0011-022#
E	Data cable, USB (A) to USB (A), 3 m	1	051-0192-000#

Using PocketMax to Communicate with the R330

Hemisphere's PocketMax is a free utility program that runs on your Windows PC or Windows mobile device. Simply connect your Windows device to the R330 via the COM port and open PocketMax. The screens within PocketMax allow you to easily interface with the R330 to:

- Select the internal SBAS, beacon, L-band, or RTCM correction source and monitor reception
- Configure GPS message output and port settings
- Record various types of data
- Monitor the R330's status and function

PocketMax is available for download from the Hemisphere GPS website (www.hemispheregps.com).



Chapter 2: Installing the R330

Mounting the Receiver

Mounting the Antenna

Routing and Connecting the Cables

Connecting the Receiver to External Devices

Default Parameters

This chapter describes how to mount the receiver and antenna, connect the cables and external devices, configure the receiver, and provides default settings and environmental considerations.

Mounting the Receiver

Note: Although you are not required to mount the receiver, you may want to do so to prevent damage to the receiver and any cables connected to the receiver.

When mounting the receiver, adhere to the following guidelines:

- Install the receiver inside and away from the elements and in a location that minimizes vibration, shock, extreme temperatures, and moisture
- Ensure the front panel (menu screen, LEDs, and buttons) is visible and accessible
- Ensure the top panel (ports/connectors) is easily accessible to connect/switch out cables and turn power on and off
- Although the R330 is splash-proof in case of accidental exposure, it is designed for indoor use (see Table C-7 on page 45 for R330 environmental specifications)

Note: There is an option within the menu to switch (flip 180°) the direction of the display. If it is easier to mount the unit upside down, you can mount it this way and still operate the display.

Figure 2-1 illustrates the typical mounting orientation of the R330.



Figure 2-1: Receiver mounting orientation

Figure 2-2 shows the dimensions (including attached mounting brackets) of the R330. Use Figure 2-2 when using the receiver mounting procedure that follows and see Figure 2-3 on page 10 for ports/connections.

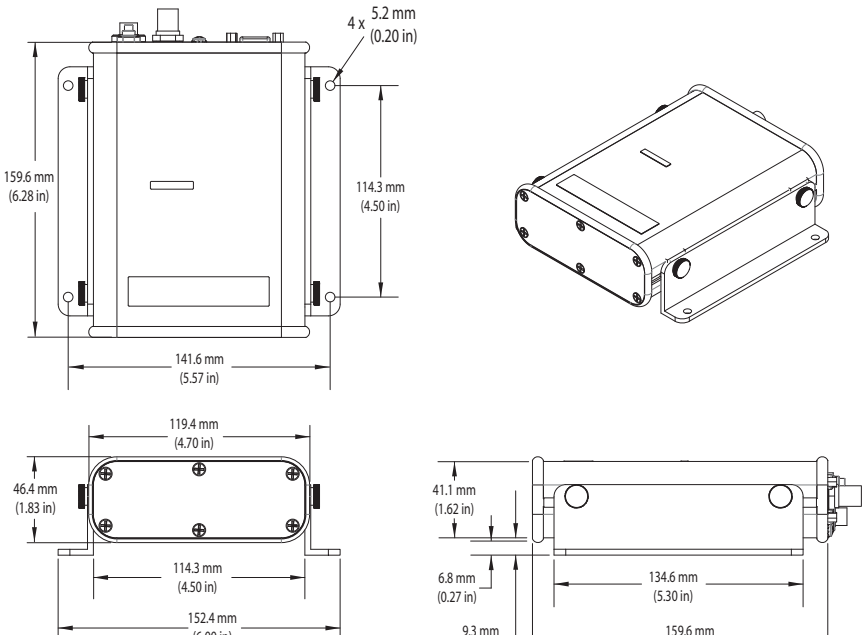
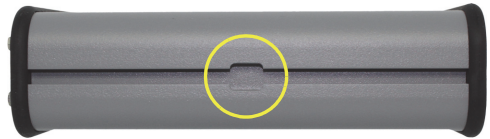

Figure 2-2: R330 dimensions (with mounting brackets)

To mount the receiver:

1. Locate the thumbscrews, nuts, and brackets included in your kit.
2. Slide the nuts through the opening (circled at right) along both sides of the receiver.



3. Place the bracket alongside the receiver and insert the thumbscrews (two thumbscrews per bracket) so they screw into the nuts.
4. Using the remaining holes in the brackets (two holes per bracket) screw down the brackets in your preferred location.



Note: Hemisphere GPS does not provide the screws in this step.

Use the remaining holes in the brackets to secure the receiver in your preferred location

Mounting the Antenna

Note: The antenna, antenna cable, and any related antenna mounting hardware are purchased separately.

Proper antenna placement is critical to positioning accuracy. When mounting the antenna, adhere to the following:

- Make sure the antenna has a clear view of the sky (an obstructed view of the sky may impair system performance)
- Mount the antenna on, or as close to, the measurement center point (the GPS engine inside the receiver computes a position based on measurements from each satellite to the phase center of the antenna)
- Position the antenna as high as possible
- Antenna is designed for outdoor use (see Table C-7 on page 45 for R330 environmental specifications)

You can mount the antenna as follows:

- Magnetic mount
- Pole mount
- Surface mount

Magnetic Mount

The magnetic mount can be screwed into the bottom of the antenna and mounted to metal surfaces. The magnetic mount includes a metal disc and foam adhesive that allow you to bond the metal disc to the desired mounting location if there are no metal surfaces. You then place the magnetic mount on the metal disc.

To attach the antenna using the magnetic mount:

1. Clean and dry the surface where you will attach the metal disc.
2. Remove the backing from one side of the foam adhesive and press the adhesive onto the mounting surface.
3. Remove the backing from the other side of the foam adhesive and press the metal disc onto the mounting surface, applying firm pressure to ensure good adhesion.
4. Place the magnetic mount (with antenna attached) on top of the metal disc.

Pole Mount

The center thread of the antenna is 5/8" for compatibility with a survey pole (not included). Simply thread the pole into the antenna.

Surface Mount

As an alternative to the magnetic mount, you can attach the antenna directly to the mounting surface with four machine screws (no. 8-32).

To attach the antenna directly to the mounting surface:

1. Photocopy the bottom of the antenna and use it as a template to plan the mounting hole locations.

▲WARNING: Make sure the photocopy is scaled one to one with the mounting holes on the bottom of the antenna.

2. Mark the mounting hole centers, as necessary, on the mounting surface.
3. Place the antenna over the marks to ensure the planned hole centers align with the true hole centers (adjusting as necessary).
4. Use a center punch to mark the hole centers.
5. Drill the mounting holes with a 3/16" bit appropriate for the surface.
6. Place the antenna over the mounting holes and insert the mounting screws through the bottom of the mounting surface and into the antenna.

▲WARNING: When installing the antenna, hand tighten only. Damage resulting from overtightening the antenna is not covered by the warranty.

Routing and Connecting the Cables

Adhere to the following when routing and connecting cables:

- Power cable must reach an appropriate power source
- Antenna cable must reach from the antenna to the receiver
- Data cable may connect to a data storage device, computer, or other device that accepts GPS data
- Do not run cables in areas of excessive heat
- Do not expose cables to corrosive chemicals
- Do not crimp or excessively bend cables
- Do not place tension on cables
- Coil up excess cable near unit
- Secure along the cable route using plastic tie wraps as necessary
- Do not run cables near high Voltage or strong RF noise and transmitter sources

▲WARNING: Improperly installed cables near machinery can be dangerous.

Connecting the Receiver to External Devices

Communication between the R330 and external devices occurs through two serial ports and two USB ports, as shown in Figure 2-3. You can configure the ports for a combination of NMEA 0183, binary, and/or RTCM SC-104 data.

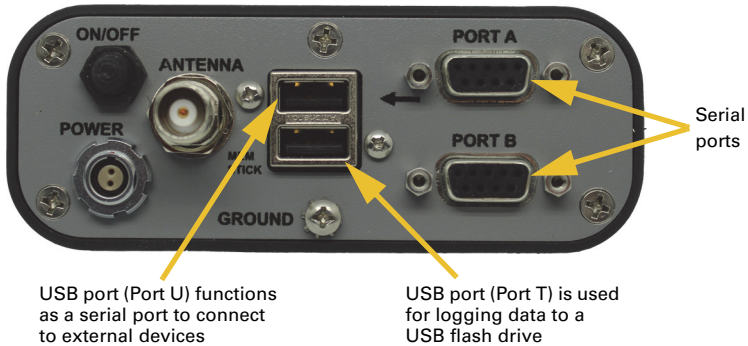

Figure 2-3: R330 serial and USB ports

The serial ports and USB ports function independently. If you connect external devices to Port A, Port B, and/or the top USB port (Port T), you can transmit and receive data between the R330 and the devices.

- The top USB port (Port U) is designed to be connected to a host device such as a PC. When you connect a PC to the R330 the PC should recognize it as a serial device and a new COM will appear as a valid connection on the PC. Set the communication software to use this new port to access the R330.
- The bottom USB port (Port T) is used for data logging to a USB flash drive (see “Data Logging Menu” on page 49).

Note: If you connect the supplied USB cable to Port T or connect a USB flash drive to Port U, the USB functionality will not work as the USB ports are not interchangeable.

- The serial ports operate at the RS-232 interface level to communicate with external data loggers, navigation systems, and other devices. Either serial port can also be used for firmware updates. Figure 2-4 illustrates the numbering for the female DB9 port (the numbering for each male connector is a mirror reflection of Figure 2-4) and Table 2-1 provides the pin configuration for the serial ports.

Note: For successful communication you must set the baud rate of the R330's serial ports to match that of the connected devices.

Table 2-1: Port A/Port B pinout descriptions**Figure 2-4: Port A/Port B pinout**

Pin	Port A Description	Port B Description
1	Not connected	Not connected
2	Transmit data Port A	Transmit data Port B
3	Receive data Port A	Receive data Port B
4	Not connected	Not connected
5	Signal ground	Signal ground
6	Not connected	Event marker
7	Not connected	Not connected
8	Not connected	Not connected
9	5V output, 350 mA max	1 PPS

Default Parameters

The following represents the standard configuration for the R330. For more information on these commands refer to the Hemisphere GPS Technical Reference (go to www.hemispheregps.com and click the GPS Reference icon).

Note: Use the \$JSAVE command to save changes you make to the R330 configuration for the changes to be present in subsequent power cycles. To reset the R330 to its default parameters you can re-install the configuration file (shown below)—contact your dealer or Hemisphere GPS Technical Support for information on obtaining and re-installing the configuration file.

```

JOFF
$JOFF, PORTA
$JOFF, OTHER
$JBAUD, 19200, OTHER
$JBAUD, 19200
$JSAVE

```



Chapter 3: Operating the R330

Powering the Receiver On/Off

Status LED Indicators

Startup

Menu System Overview

Configuring the R330

USB Data Logging

The R330 is designed for easy operation with LED indicators and a straightforward menu system. This chapter discusses how to:

- Power the receiver on/off
- View/interpret LED indicators
- Use the built-in menu system
- Set the differential source
- Log data

Powering the Receiver On/Off

The R330 has a hard power switch located on the top panel.



Figure 3-1: R330 power switch

The R330 accepts an input voltage of 8 to 36 VDC via the power cable. The supplied power should be continuous and clean for best performance. Table C-6 on page 45 provides the power specifications of the R330.

WARNING: Do not apply a voltage higher than 36 VDC. This will damage the receiver and void the warranty. Also, do not attempt to operate the R330 with the fuse bypassed as this will void the warranty.

The R330 features reverse polarity protection to prevent damage if the power leads are accidentally reversed. Although the R330 proceeds through an internal startup sequence when you apply power, it will be ready to communicate immediately.

Initial startup may take 5 to 15 minutes depending on the location. Subsequent startups will output a valid position within 1 to 5 minutes depending on the location and time since the last startup.

The R330 may take up to 5 minutes to receive a full ionospheric map from SBAS. Optimum accuracy is obtained once the R330 is processing corrected positions using complete ionospheric information.

To power on the R330:

1. Connect the ends of the R330 power cable to a clean power source providing 8 to 36 VDC.

Note: Hemisphere GPS recommends you use a weather-tight connection and connector if the connection is located outside.

2. Press the Power button on the top panel.



To power off the R330:

- Press the Power button on the top panel.

Status LED Indicators

The R330 uses LEDs to indicate power, GPS lock, and DGPS position. Table 3-1 describes each LED indicator.

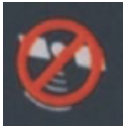
Table 3-1: LED indicators

LED	Function	LED Color	Description
	Power	Red	Illuminates solid red when the receiver is powered on.
	GPS	Yellow	Illuminates solid yellow when the receiver achieves a solid GPS lock.
	DGPS	Green	Illuminates solid green when the receiver achieves a differential position and a pseudorange residual of better than 10.0 m. If the residual value is worse than the current threshold, the LED blinks green indicating differential mode has been attained but the residual has not met the threshold.

Startup

When you power on the R330 the Hemisphere GPS splash screen appears followed by the main screen, or Top menu (see at top right). Press the Down Arrow button to display the remaining items on the Top menu (see at bottom right).

You use the menus to view and configure system data and settings for the following Top menu items:

- GNSS
- Differential (menu item will be the selected differential source, such as SBAS or Autonomous)
- Config Wizard
- System Setup
- Data Logging

For a complete menu path of each Top menu item, see Appendix B, “Menu Map.”



Menu System Overview

The R330 menu system is designed for easy setup and configuration of the unit in or out of the field and supports multiple languages. You can perform most configuration tasks entirely through the menu without having to connect to a PC or PDA.

Menu Display

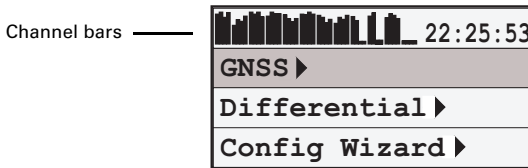

Figure 3-2: R330 menu

The bars along the top left of the display offer a visual representation of each channel's tracking status (one bar section for each channel). Depending on what signals you're tracking, the bars represent something different, where:

- If you're tracking L1 GPS only, each bar represents L1 GPS.
- If you're tracking L1/L2 GPS, each bar is two separate bars (starting from the left, first bar for L1 GPS, second bar for L2 GPS)
- If you're tracking L1/L2 GPS and GLONASS, each bar is four separate bars (starting from the left, first bar for L1 GPS, second bar for L2 GPS, third bar for L1 GLONASS, fourth bar for L2 GLONASS)

Navigating the Menus

The R330 front panel contains the three soft buttons shown at right: Up Arrow, Enter, and Down Arrow.



Up Arrow button - moves to the previous menu item or to the previous selection within a menu item





Enter button - displays a submenu or selects an option within a menu item



Down Arrow button - moves to the next menu item or to the next selection within a menu item

Table 3-2 describes the indicators to the right of specific menu items.

Table 3-2: Menu item indicators

Indicator	Purpose	Example
 Display indicator	<p>Goes to the indicated submenu.</p> <p>This indicator also appears to the right of the “Back” and “Top Menu” menu items.</p> <ul style="list-style-type: none"> • Press Enter when “Back” is selected to return to the previous menu. • Press Enter when “Top Menu” is selected to return to the Top menu. 	<ol style="list-style-type: none"> 1. On the Top menu press the Down Arrow button to highlight System Setup. The Display indicator appears to the right of System Setup. 2. Press Enter to display the System Setup menu. 3. Press the Down Arrow button again to highlight the Display Format option and then press Enter. The items on the Display Format menu appear and the Select indicator appears to the right of Disp Update (the first item on the Display Format menu).
 Select indicator	<p>Scrolls within a menu to highlight an option to select.</p>	<ol style="list-style-type: none"> 4. Press Enter on the Disp Update item. The Display indicator changes to the Select indicator. 5. Press the Up Arrow or Down Arrow button to scroll through the available options (such as 1Hz and 5Hz). 6. Press Enter on the highlighted option to select it. That option is now the setting for the menu item and the Select indicator changes back to the Display indicator.

To return the menu system to the factory default configuration:

- Press and hold the Enter and Up Arrow buttons and then power up the receiver until the splash screen disappears.

Menu and Menu Item Selection in This User Guide

For many instructions in this User Guide the following example illustrates the nomenclature used for making navigating the menus:

“On the Main menu select **Data Logging > Config**” is the equivalent to saying “On the Main menu select **Data Logging** and press **Enter**. Then select **Config** and press **Enter**.”

When making selections for a menu item, such as selecting Yes or No for Auto-Name (Data Logging > Config menu), the instructions will indicate to select the menu item and press Enter to allow you to then select an option for that menu item and then press Enter again to select that option.

Configuring the R330

The Config Wizard menu guides you through various configuration options, enabling you to save up to five different configurations that are useful when using the R330 on different vessels or for different applications.

If you use a Windows PC or Windows mobile device, you can use Hemisphere GPS' VectorPC software to configure the R330. See "Using PocketMax to Communicate with the R330" on page 4 for more information.

Config Wizard Menu

This section describes the basic Config Wizard options you need to set to get up and running. Figure 3-3 outlines the menu structure of the Config Wizard menu.

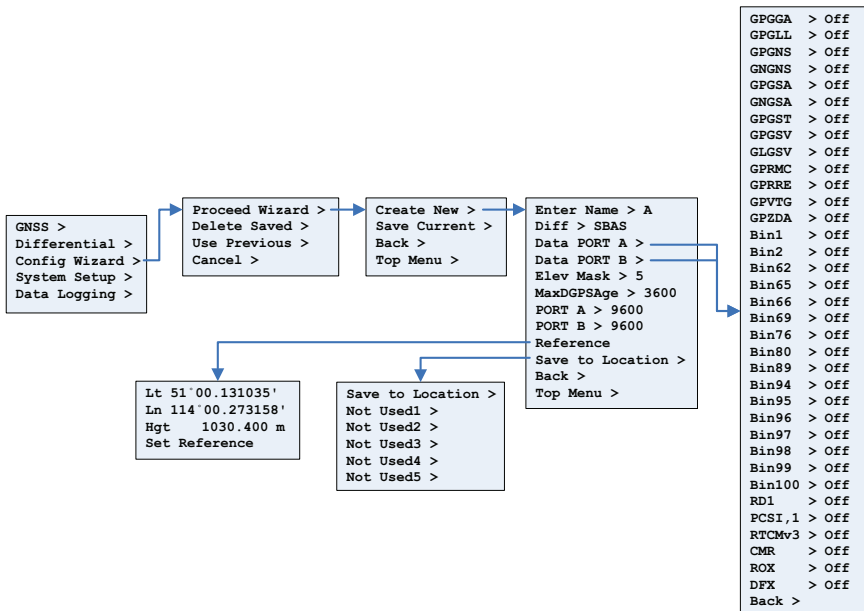

Figure 3-3: Config Wizard menu

Using the Config Wizard

The basic setup instructions outlined in this section assume the antennas are:

- Installed parallel to, and along the centerline of, the vessel's axis
- Separated by 1.0 m

If this is not the case, you will need to enter the actual antenna separation and bias in the Config Wizard.

1. Select **Config Wizard > Proceed Wizard**. The Proceed Wizard menu appears.
2. Select **Create New** to create a new configuration. You are prompted to enter a name for your configuration. In addition to the Name you can set the options shown at right (also shown in Figure 3-3 on the previous page).

```

Enter Name > A
Diff > SBAS
Data PORT A >
Data PORT B >
Elev Mask > 5
MaxDGPSAge > 3600
PORT A > 9600
PORT B > 9600
Reference
Save to Location >
Back >
Top Menu >
  
```

Note: For help on using the menus to view and setting values see "Startup" on page 16.

3. *Enter a name:*
 - a. Use the arrow buttons to select a character and then press the **Enter** button to save the character. The cursor moves to the right.
 - b. Repeat step a for each additional character in the name.
 - c. Scroll through the list of characters until you reach "↵" and press the **Enter** button to accept the name. You are returned to the previous menu and the name you entered appears next to "Enter Name."

If you are editing an existing name, for characters you want to replace simply select a different character. If the new name is shorter and you need to delete unneeded characters to the right:

- a. After you change the final character in the new name press the **Enter** button repeatedly until the last character is highlighted.
- b. Scroll through the list of characters until you reach "◀" and press the **Enter** button to delete the character. The cursor moves to the left.
- c. Repeat step b for each additional rightmost character you want to delete.
- d. Scroll through the list of characters until you reach "↵" and press the **Enter** button to accept the name. You are returned to the previous menu and the name you entered appears next to "Enter Name."

4. *Set a DGPS source:* From the same menu, select **DIFF**. The options are:
 - SBAS (default)
 - Beacon
 - Autonomous
 - e-Dif
 - L-band
 - RTK
 - Extern RTCM (External RTCM)

5. *Change the type of GPS data message sent to the data ports:* Select either **Data Port A** or **Data Port B** from the menu list.
6. *Set the elevation cutoff angle:* Select **Elev Mask** and set the angle between 0° and 45°. The default value is 5°.
7. *Set the maximum DGPS age:* The maximum DGPS age is 2700 seconds (45 minutes) by default.
8. *Configure baud rates:* If the default baud rate on the selected port does not match that of the external device you are connecting to, you will need to configure the Baud Rate, using the Port A or Port B entries. 4800, 9600, 19200, 38400, 57600, and 115200 are the available baud rates.
9. *Save your configuration:* To save your new configuration, select the Save to Location field. You will be prompted for a location to save your configuration.

Select one of the empty slots, noted by the name Not Used or select a slot with an existing configuration to overwrite it.

After your configuration is saved, you must select it from the Config Wizard in order to activate it. You may then continue to enter different receiver configurations without upsetting the current operation of the receiver. Re-enter the Config Wizard and select the configuration to use.

USB Data Logging

When you insert a USB flash drive into the R330, the Data Logging menu indicates you can start recording (logging data) and displays the free space on the flash drive (see Figure 3-4). When you start logging data the “Start Recording” indicator changes to “End <filename>.”

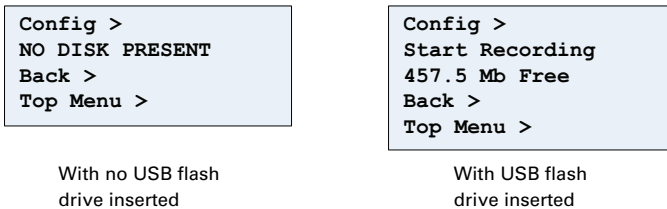

Figure 3-4: USB flash drive indicators on Data Logging menu

⚠ WARNING: Stop data logging before removing the USB flash drive from the R330. Failure to do so may result in a loss of data.

Selecting the Data File Type and Log Options

You can log the following data types to a USB flash drive:

- RAW - binary, NMEA, and other data options (see Table 3-3)
- KML - Google Earth KML format with latitude, longitude and height
- CSV - comma-separated value (CSV) format with time, latitude, longitude, and height
- PostPro - R330 automatically turns on the appropriate messages for post processing
- debug - R330 logs high speed data for troubleshooting purposes (contact Hemisphere GPS Technical Support for more information)

Table 3-3: RAW data log options

Format	Description
Raw (binary)	For raw (binary) data logging, you may also want the receiver configuration to be inserted into the file. If you select this option the file will start with the receiver configuration comprised of the replies to the \$JI, \$JK, \$JT, and \$JSHOW queries.
NMEA	National Marine Electronics Association (NMEA 0183) - industry standard data transmission format
CMR	Proprietary data correction format
DFX	Hemisphere GPS-proprietary data correction format
ROX	Hemisphere GPS-proprietary data correction format
RTCM	Radio Technical Commission for Maritime Services - industry standard data correction format

To select a data logging type:

1. Select **Data Logging > Config > FileType**.
2. Press the **Up/Down Arrow** buttons until your preferred data type appears then press **Enter**.

When logging using the RAW data type (File Type > RAW as shown in Figure 3-5) you can select which data to log and at what rate by selecting Data Logs and then making the desired selections on the Data Logs menu.

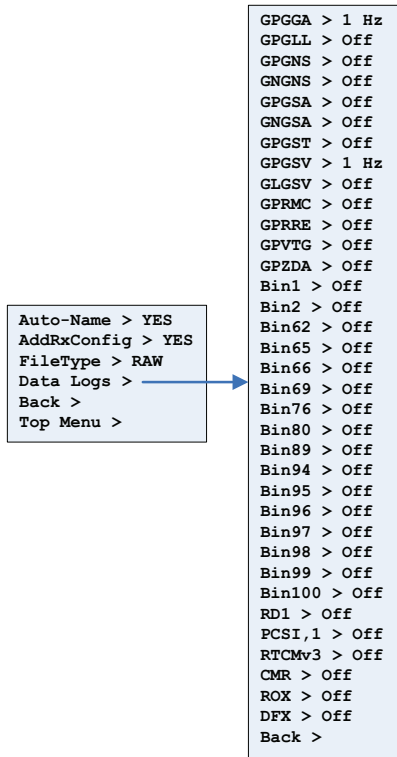

Figure 3-5: Data Logging > Config > Data Logs menu

*Note: Logged data options are limited by your receiver subscriptions (certain options may not appear on the Data Logs menu without a specific subscription). For example, GNGNS, GNGSA, GLGSV, Bin62, Bin65, Bin66, and Bin69 only appear on the Data Logs menu if you are authorized to receive GLONASS. To view your subscriptions press **System Setup > Software Disp > Authorizations**.*

Logging Data to a File

You can log data to a file that the R330 auto-generates or you can manually enter a filename to which to log data. You can append data to or overwrite data on a manually-named file; however, you cannot append data to or overwrite data on an R330-generated file.

To log data to an R330 auto-generate filename:

1. Select **Data Logging > Config**.
2. If Auto-Name displays No select **Auto-Name** and then press **Enter**.
3. Select **Yes** and then press **Enter**.

4. Select **Back** to return to the Data Logging menu.
5. Select **Start Recording** to begin logging data. The Start Recording option changes to End <filename>.
6. Select **End <filename>**.

To log data to a manually-created filename:

1. Select **Data Logging > Config**.
2. If Auto-Name displays Yes select **Auto-Name** and then press **Enter**.
3. Select **No** and press **Enter**. The Enter Name and Mode menu items appear below Auto-Name.
4. Enter a filename:
 - a. Select **Enter Name** and press **Enter**.
 - b. Enter the desired characters for the filename and then scroll to the return character and press **Enter**.
5. Select the mode:
 - a. Select **Mode** and press **Enter**.
 - b. Select **Append** to log data to new file or to append data to an existing file (based on the filename in step 4) and press **Enter**.

or

Select **Overwrite** to overwrite an existing file (based on the filename in step 4) and press **Enter**.

▲WARNING: No warnings are given to confirm overwriting a previous file.

6. Select **Back** to return to the Data Logging menu.
7. Select **Start Recording** to begin logging data. The Start Recording option changes to End <filename>.
8. Select **End <filename>**.

Data Post-Processing

After you log data you can then process the data with a Receiver Independent Exchange (RINEX) format software utility. Hemisphere GPS Rinex conversion software is available from the Hemisphere GPS website at www.hemispheregps.com.

Make sure you select PostPro as the file type before logging the data you will use for post processing (see "Selecting the Data File Type and Log Options" on page 22).

To post-process raw data:

1. Log the raw data to the USB flash drive inserted in the R330. Make sure you properly end your data logging before removing the flash drive in step 2 below.
2. Remove the flash drive from the R330 then insert the drive in a PC with Hemisphere GPS' Rinex conversion software installed.
3. Run the Rinex conversion software.



Chapter 4: RTK

Installing the Base Station

Installing the Rover Radio

Using the R330 as a Base Station or Rover

RTK Operation

RTK provides the highest accuracy (see Table C-1 on page 44 for accuracy specifications). You can set up a base/rover RTK system using one R330 as a base station and one R330 for each rover. Most commonly, each base station and rover include the following:

- GPS receiver
- GPS antenna
- Radio: transmitter for base station, receiver for rover
- Power source

Installing the Base Station

The base station tracks GPS signals and broadcasts differential corrections to a radio and rover GPS receiver. You typically set up the base station near the working area and at a location with no obstructions between the base station and rover radio.

When installing the base station adhere to the following:

- Do not place the base station near metal objects
- Make sure the base station is at least 50 m from obstructions
- Make sure the base station and rover radio have a clear line of sight up to 5 km or less depending on the radio type when operating RTK

Installing the Rover Radio

The rover GPS system processes the corrections and outputs highly accurate position information.

When installing the rover radio adhere to the following:

- Ensure the rover radio and GPS antenna are at least 1 m apart
- Rover radio must not block the GPS antenna
- Rover radio must receive regular corrections from the base station every one to two seconds (differential age) for up to 15 minutes to achieve RTK lock (maximum accuracy) - typically, a lock is achieved within five minutes

Using the R330 as a Base Station or Rover

Using the R330 as a base station or rover receiver requires a link between the base and rover to transfer differential correction data from the base to the rover. The link can be wired or wireless (such as a radio modem).

Setting Up the R330 as a Base Station

When you set up the R330 as a base station, the Base Station menu option appears just below Differential on the Top menu.

The baud rates of the base, rover, and radio (if part of the setup) must be the same.

```
GNSS >
Differential >
Base Station >
Config Wizard >
System Setup >
Data Logging >
```

Note: Before you can set up your R330 as a base station, your unit must be subscribed for base station functionality. Contact your Hemisphere GNSS sales representative for more information.

To set up the R330 as a base station:

1. *Put the R330 in base station mode:* From the Top menu press **GNSS > Configure > Rx Modes** then set **BASE** to **YES**.

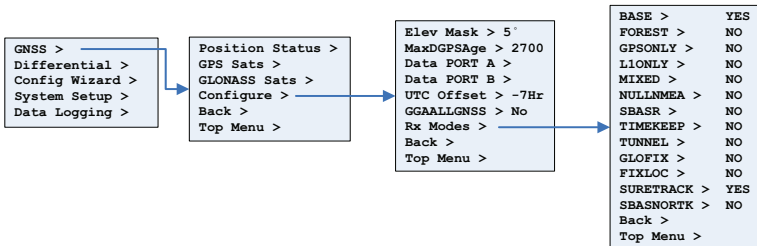

2. *Select your differential corrector:* From the Top menu press **Differential > Include** then set your preferred RTK corrector to **YES** (ROX set to YES in example below). RTK appears below Include once you set one of the following to YES: CMR, RTCM3, ROX.

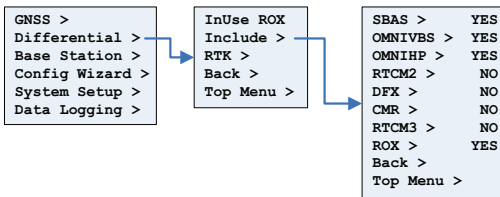

3. *Set the differential port and baud rate of the base station:* From the Top menu press **Differential > RTK** then set **DiffPort** to your preferred

differential port and set **DiffBaud** to your preferred baud rate (PORT B and 19200, respectively, in example below).

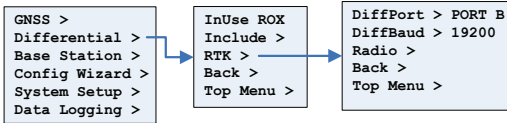

4. *Set the position of the base station:* From the Top menu press **Base Station > Reference > Use Current Pos** to use your current position.

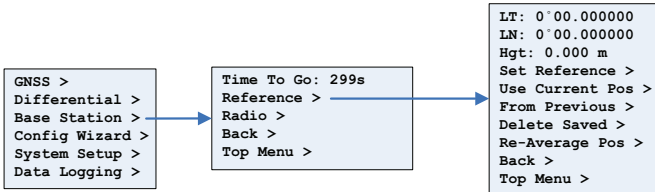

Setting Up the R330 as a Rover

The baud rates of the base, rover, and radio (if part of the setup) must be the same.

Note: Before you can set up your R330 as a rover, your unit must be subscribed for rover functionality. Contact your Hemisphere GNSS sales representative for more information.

To set up the R330 as a rover:

1. *Select your differential corrector:* From the Top menu press **Differential > Include** then set your preferred RTK corrector to **YES** (ROX set to YES in example below). When the base station sends correctors to the rover the Differential menu shows the corrector type next to InUse and RTK below Include.

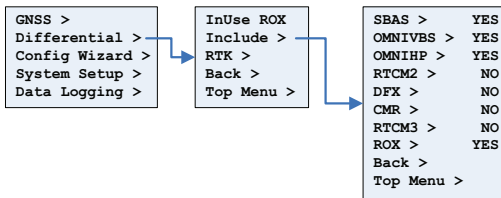

2. *Set the differential port and baud rate of the base station:* From the Top menu press **Differential > RTK** then set **DiffPort** to your preferred differential port and set **DiffBaud** to your preferred baud rate (PORT B and 19200, respectively, in example below).

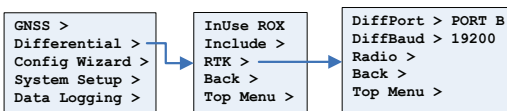

Connecting the R330 to a Base/Rover Radio

When connecting the R330 to a base/rover radio, verify/set the following:

- Radio does not interfere with GPS
- Radio supports a serial connection, with a minimum of 9600 baud, set to N,8,1
- Radio supports over-the-air throughput of at least 300 bps
- Base station, rover, and radio all are set to the same baud rate

Note: Hemisphere GPS recommends testing with a wired condition prior to using a radio connection to ensure communication parameters are properly defined. Make sure both the rover radio and base station are on the same channel or frequency in order for the rover radio to receive corrections from the base station.

RTK Operation

After you set up your RTK system, the status LEDs indicate the following (see “Status LED Indicators” on page 15 for more information on R330 LED indicators):

- Yellow (GPS LOCK LED): tracking GPS
- Flashing green (DIFF LED): differential has been attained, but the residual has not met the threshold
- Solid green (DIFF LED): RTK lock

The R330 will output standard NMEA messages through Port A or Port B. Set the message and port output as preferred (see “Config Wizard Menu” on page 19 for more information on message output).



Appendix A: Troubleshooting

Table A-1 provides troubleshooting information for the R330.

Table A-1: Troubleshooting

Problem	Possible Solution
Receiver fails to power	<ul style="list-style-type: none"> • Verify polarity of power leads • Check integrity of power cable connections • Check power input voltage (8 - 36 VDC) • Check current restrictions imposed by power source (maximum is 250 mA @ 12 VDC) • Press the Power button
No data from R330	<ul style="list-style-type: none"> • Check receiver power status (red LED) • Check integrity and connectivity of power and data cable connections • The volume of data requested to be output by the R330 could be higher than what the current baud rate supports. Try using 19200 or higher as the baud rate for all devices.
No GPS lock	<ul style="list-style-type: none"> • Check integrity of cable connections • Verify antenna's clear view of the sky
No SBAS lock	<ul style="list-style-type: none"> • Check integrity of cable connections • Verify antenna's clear view of the sky • Check SBAS visibility map
No beacon lock	<ul style="list-style-type: none"> • Check beacon listings to ensure proximity to a beacon station • Ensure there are no sources of interference nearby • Check antenna connections • Verify MSK rate is set correctly • Verify frequency of transmitting beacon • Select alternate antenna position
No L-band DGPS service lock	<ul style="list-style-type: none"> • Subscription activated and not expired • Check antenna connections • Verify antenna's clear view of the sky



Appendix B: Menu Map

GNSS Menu
Differential Menu
Config Wizard Menu
System Setup Menu
Data Logging Menu

This appendix shows the complete menu map for each menu (listed below) on the R330 Top menu:

- GNSS
- Differential (menu item will be the selected differential source, such as SBAS or Autonomous)
- Base Station (appears only if you set BASE to YES—see “Setting Up the R330 as a Base Station” on page 27)
- Config Wizard
- System Setup
- Data Logging

GNSS Menu

Use the GNSS menu to view and edit your GNSS settings. Settings include the data port outputs, specific positioning parameters, UTC time offset, and satellite visibility and positioning information.

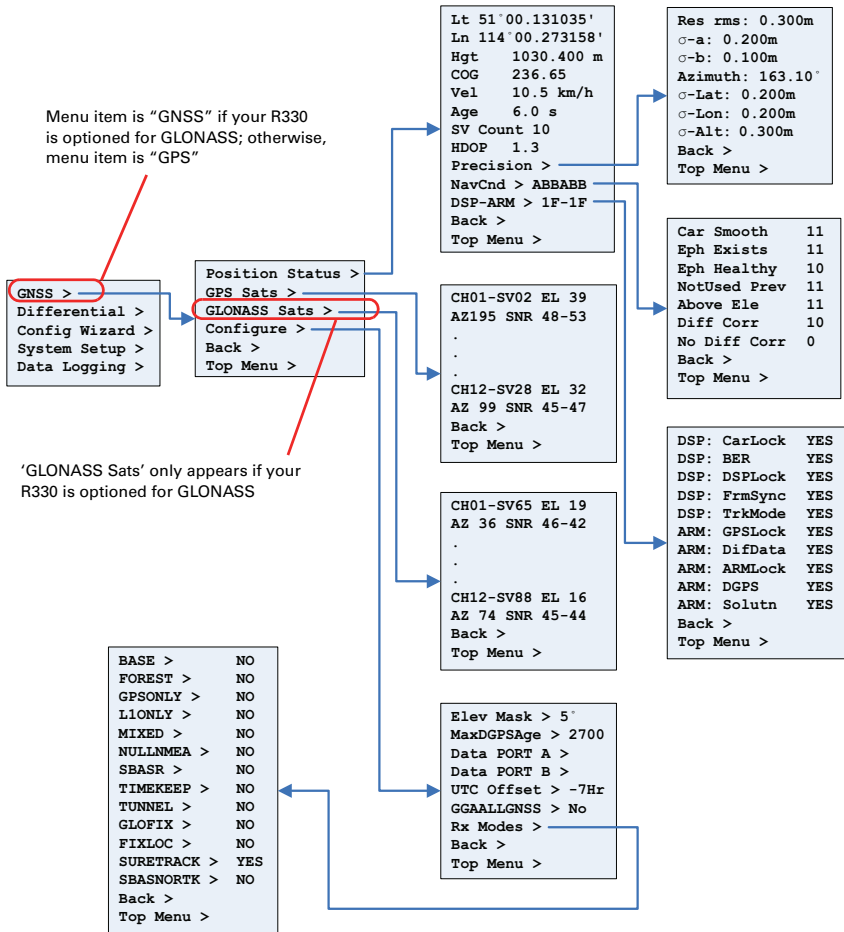

Figure B-1: GNSS menu

Differential Menu

Use the Differential menu to view or change your differential settings. The following available differential sources depend on the configuration you purchased.

- SBAS
- Beacon (RTCM2) - available with purchased unlock code
- RTK (CMR, ROX, RTCM3)
- L-band (OMNIVBS, OMNIHP) - available with purchased unlock code
- None (Autonomous)

To select the differential source:

1. Press **Differential > Include** then set each format you may use to **Yes**. For example, if you will be using Beacon, set RTCM2 to Yes.
2. Press **Back** to return to the previous menu level, press **InUse**, then select your preferred differential source. For example, if you will be using Beacon, select Beacon (RTCM2 will be displayed when finished).

Figure B-2 through Figure B-5 show the complete menu maps for the SBAS, Beacon, RTK, L-band, and Autonomous, respectively. The Include menu (at right) in each of these figures shows all available formats. If you have not purchased unlock codes for L-band and Beacon, the OMNIVBS/OMNIHP (L-band) and RTCM2 (Beacon) menu items will not appear on your menu.

SBAS >	YES
OMNIVBS >	YES
OMNIHP >	YES
RTCM2 >	YES
DFX >	NO
CMR >	NO
RTCM3 >	NO
ROX >	NO
Back >	
Top Menu >	

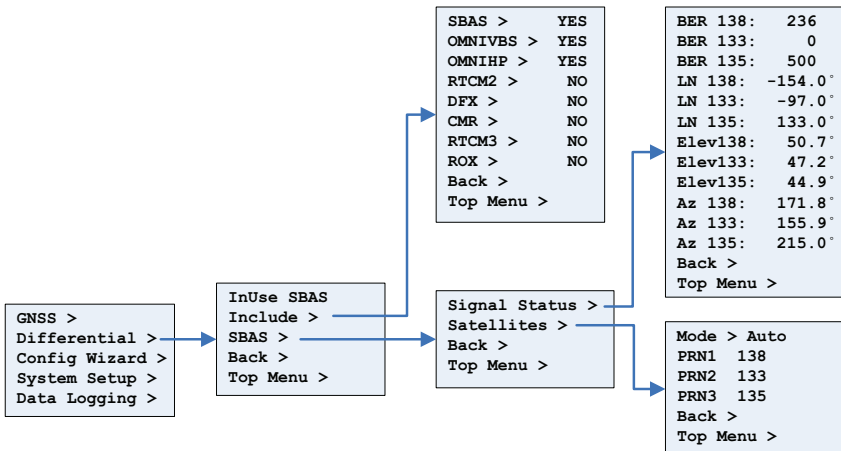

Figure B-2: SBAS menu

The RTK corrector format you select appears next to "InUse" (ROX shown here)

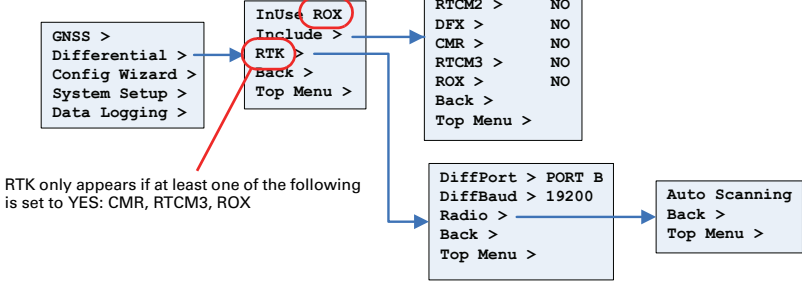

Figure B-3: RTK menu

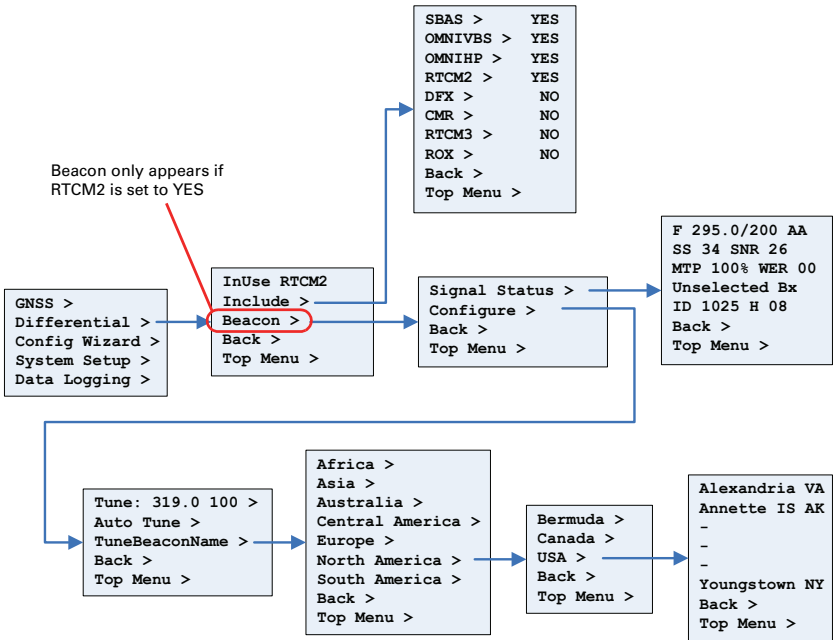

Figure B-4: Beacon menu

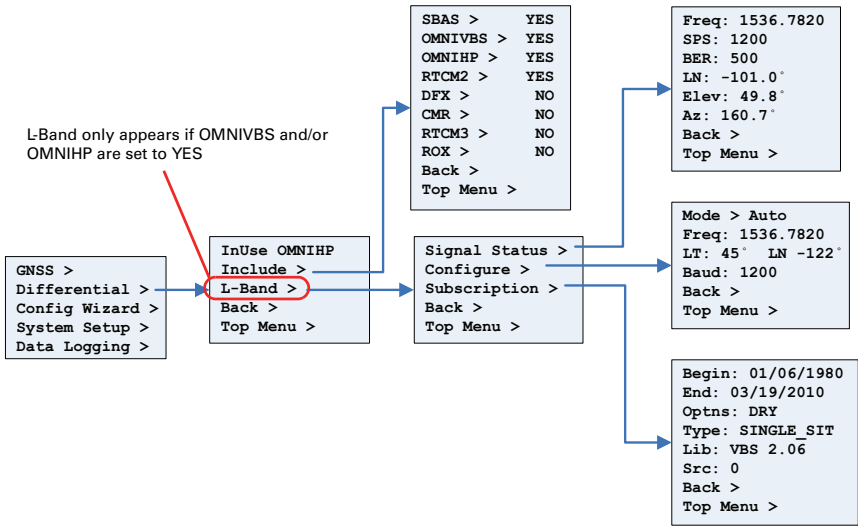

Figure B-5: L-band menu

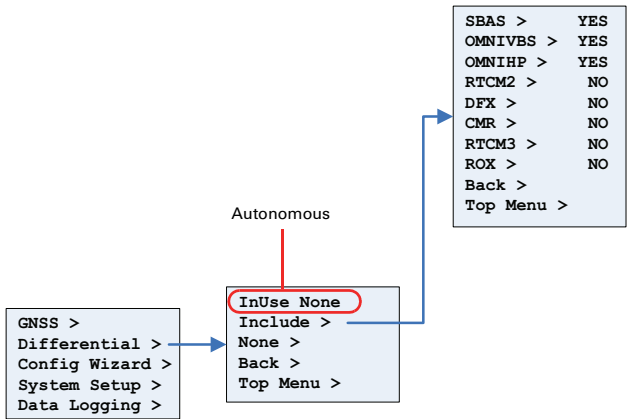

Figure B-6: Autonomous menu

Base Station Menu

The Base Station menu enables you to configure an R330 as a base station. This menu only appears if you set BASE to YES—see “Setting Up the R330 as a Base Station” on page 27.

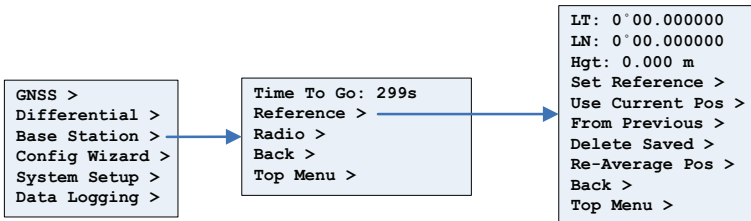

Figure B-7: Base Station menu

Config Wizard Menu

The Config Wizard walks you through basic settings to get up and running. See “Configuring the R330” on page 19 to view the Config Wizard menu map.

System Setup Menu

The System Setup menu allows you quickly view and edit current system settings. General settings include such items as current applications, units, baud rates, logs, LED contrast, subscription code, display orientation (you can flip the display 180° by selecting *YES* under *Flip Display*), and language.

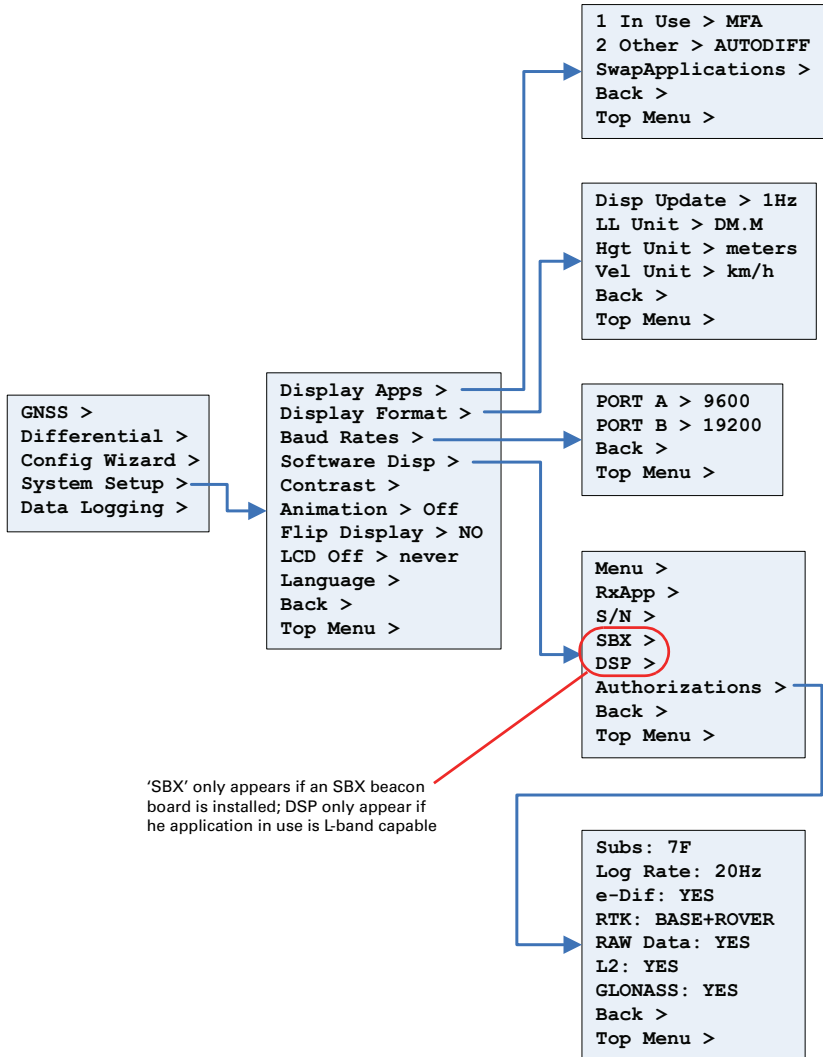

Figure B-8: System Setup menu

Data Logging Menu

The Data Logging menu allows you to log or output job data, view USB flash drive free storage space, set up file auto-naming, and view what type of data you are logging.

Logged data options are limited by your receiver subscriptions (certain options may not appear on this menu without a specific subscription. For example, GNGNS, GNGSA, GLGSV, Bin62, Bin65, Bin66, and Bin69 only appear on this menu if you are authorized to receive GLONASS.

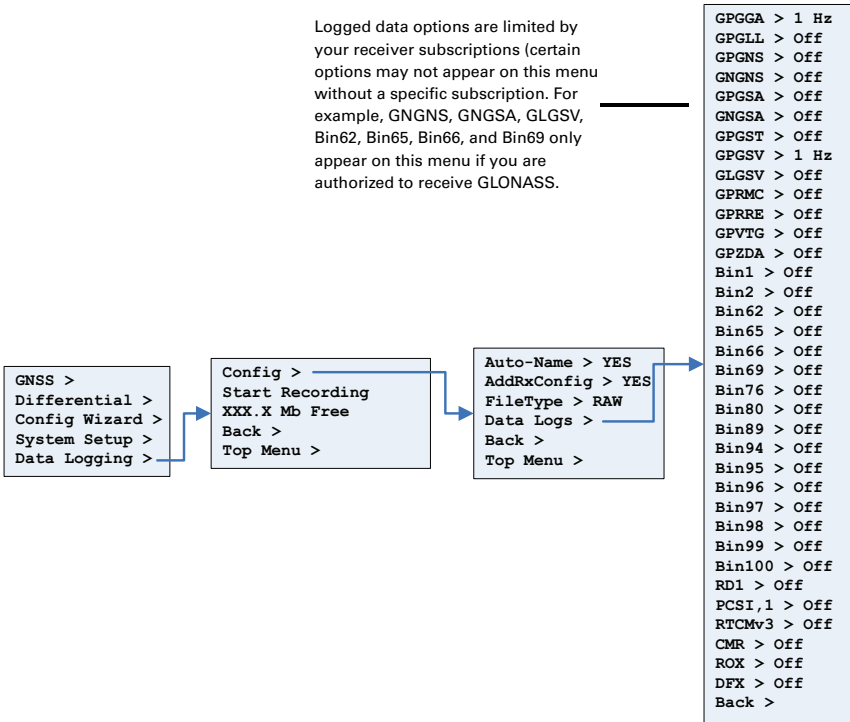

Figure B-9: Data Logging menu



Appendix C: Technical Specifications

Table C-1 through Table C-8 provide the technical specifications for the R330.

Table C-1: GNSS sensor specifications

Item	Specification
Receiver type	GNSS L1 and L2, RTK with carrier phase
Signals received	GPS, GLONASS, and BeiDou ¹
Channels	270
SBAS tracking	3-channel, parallel tracking
Update rate	10 Hz standard, 20 Hz optional
Timing (1 PPS) accuracy	20 ns
Cold start time	< 60 s typical (no almanac or RTC)
Warm start time	< 30 s typical (almanac and RTC)
Hot start time	< 10 s typical (almanac, RTC, and position)
Maximum speed	1,850 kph (999 kts)
Maximum altitude	18,288 m (60,000 ft)
Differential options	SBAS, autonomous, external RTCM, RTK, and L-band DGNSS/HP/XP/G2 ²

Table C-2: Positioning accuracy specifications

RMS (67%)	Horizontal	Vertical
Single Point, no SA	1.2 m	2.5 m
SBAS (WAAS) ³	0.3 m	0.6 m
L-band DGPS	0.3 m	0.6 m
Code differential GPS	0.3m	0.6 m
L-band L1/L2	0.15 m	0.3 m
RTK	10 mm + 1 ppm	20 mm + 2 ppm

Table C-3: Beacon sensor specifications

Item	Specification
Channels	2-channel, parallel tracking
Frequency range	283.5 to 325.0 kHz
Operating modes	Manual, automatic, and database
Compliance	EN50081-4-2 ESD

Table C-4: L-band sensor specifications

Item	Specification
Sensitivity	-130 dBm
Channel spacing	7.5 KHz
Satellite selection	Manual and automatic
Reacquisition time	15 s (typical)

Table C-4: L-band sensor specifications (continued)

Item	Specification
Rejection	15 kHz spacing > 30 dB 300 kHz spacing > 60 dB

Table C-5: Communication specifications

Item	Specification
Serial ports	2 full-duplex RS-232
USB ports	1 USB host, 1 USB device
Baud rates	4800 - 115200
Data I/O protocol	NMEA 0183, Hemisphere GPS binary
Correction I/O protocol	Hemisphere GPS proprietary, RTCM v2.3 (DGPS), RTK v3, CMR, CMR+ ¹
Timing output	1 PPS CMOS, active high, rising edge sync, 10 k Ω , 10 pF load
Event marker input	CMOS, active low, falling edge sync, 10 k Ω

Table C-6: Power specifications

Item	Specification
Input voltage	8 to 36 VDC
Power consumption	3.8 W nominal (WAAS and Beacon) 4.6 W nominal (L-band)
Current consumption	315 mA nominal (WAAS and Beacon) 383 mA nominal (L-band)
Antenna voltage output	15 VDC maximum
Antenna short circuit protection	Yes
Antenna gain input range	10 to 40 dB
Antenna input impedance	50 Ω

Table C-7: Environmental specifications

Item	Specification
Operating temperature	-40°C to +70°C (-40°F to +158°F)
Storage temperature	-40°C to +85°C (-40°F to +185°F)
Humidity	95%, non-condensing
Shock and vibration	Mechanical Shock: EP455 Section 5.14.1 Operational Vibration: EP455 Section 5.15.1 Random
EMC	CE (IEC 60945 Emissions and Immunity), FCC Part 15, Subpart B, CISPR22

Table C-8: Mechanical specifications

Item	Specification
Dimensions	17.8 L x 12.0 W x 4.6 H (cm) 7.0 L x 4.7 W x 1.8 H (in)
Weight	645 g (1.42 lbs)
Status LED indicators	Power, GPS lock, Differential lock, DGPS position, L-band lock
Power/data connector	2-pin metal ODU
Antenna connector	TNC-male, straight

¹Upgrade required

²Requires a subscription from L-band service provider

³Depends on multipath environment, number of satellites in view, satellite geometry, and ionospheric activity

⁴Receive only, does not transmit this format

Note: The Eclipse receiver technology is not designed or modified to use the GPS Y-Code

Index

Numerics

1 PPS output 11, 45

A

antenna

- installation with rover radio 26
- power specifications 45
- troubleshooting 32

antenna mounting

- magnetic mount 8
- overview 8
- pole mount 8
- surface mount 9

B

base station installation 26

beacon sensor specifications 44

C

cables

- connecting 9
- troubleshooting 32

CMR (RAW data option) 22

communication specifications 45

configuration

- of the system 19
- returning to factory defaults 18
- wizard 19, 39
- wizard, using 20

connecting

- cables 9
- receiver to external device or base/rover radio 29
- receiver to external devices 10

connection troubleshooting 32

CSV data format 22

D

data logging

- overview 21
- post-processing 24

DFX (RAW data option) 22

Diff (differential source)

- menu map 36

E

environmental

- specifications 45

event marker 11, 45

external devices

connecting to receiver 10

G

GNSS

- sensor specifications 44

GPS

- menu map 35

I

installation

- base station 26
- rover radio 26

K

KML data format 22

L

L-Band sensor specifications 44

LED

- indicators 15

logging data to a file (instructions) 23

M

magnetic mount (antenna) 8

menu map 16

- Diff (differential source) 36
- GPS 35
- SBAS 36
- system setup 40

mounting

- procedure (receiver) 7

mounting (antenna)

- magnetic mount 8
- overview 8
- pole mount 8
- surface mount 9

mounting (receiver) 6

mounting guidelines (receiver) 6

N

NMEA (RAW data option) 22

P

pole mount (antenna) 8

post-processing data 24

powering off the receiver 15

powering on the receiver 15

R

RAW data format 22

receiver

- connecting external devices 10

- logging data 21

- mounting 6

- mounting guidelines 6

- mounting procedure 7

- powering off 15

- powering on 15

- using as a base station or rover 27

rover radio

- installation 26

ROX (RAW data option) 22

RTCM (RAW data option) 22

RTK Operation 29

S

SBAS

- troubleshooting 32

serial port 10

setup, system, menu map 40

specifications

- beacon sensor 44

- communication 45

- environmental 45

- GNSS sensor 44

- L-Band sensor 44

surface mount (antenna) 9

U

USB data logging 21

W

wizard

- configuration 19, 39

- configuration, using 20

End User License Agreement

IMPORTANT - This is an agreement (the "**Agreement**") between you, the end purchaser ("**Licensee**") and Hemisphere GNSS Inc. ("**Hemisphere**") which permits Licensee to use the Hemisphere software (the "**Software**") that accompanies this Agreement. This Software may be licensed on a standalone basis or may be embedded in a Product. Please read and ensure that you understand this Agreement before installing or using the Software Update or using a Product.

In this agreement any product that has Software embedded in it at the time of sale to the Licensee shall be referred to as a "**Product**". As well, in this Agreement, the use of a Product shall be deemed to be use of the Software which is embedded in the Product.

BY INSTALLING OR USING THE SOFTWARE UPDATE OR THE PRODUCT, LICENSEE THEREBY AGREES TO BE LEGALLY BOUND BY THE TERMS OF THIS AGREEMENT. IF YOU DO NOT AGREE TO THESE TERMS, (I) DO NOT INSTALL OR USE THE SOFTWARE, AND (II) IF YOU ARE INSTALLING AN UPDATE TO THE SOFTWARE, DO NOT INSTALL THE UPDATE AND PROMPTLY DESTROY IT.

HEMISPHERE PROVIDES LIMITED WARRANTIES IN RELATION TO THE SOFTWARE. AS WELL, THOSE WHO USE THE EMBEDDED SOFTWARE DO SO AT THEIR OWN RISK. YOU SHOULD UNDERSTAND THE IMPORTANCE OF THESE AND OTHER LIMITATIONS SET OUT IN THIS AGREEMENT BEFORE INSTALLING OR USING THE SOFTWARE OR THE PRODUCT.

1. **LICENSE.** Hemisphere hereby grants to Licensee a non-transferable and non-exclusive license to use the Software as embedded in a Product and all Updates (collectively the "**Software**"), solely in binary executable form.
2. **RESTRICTIONS ON USE.** Licensee agrees that Licensee and its employees will not directly or indirectly, in any manner whatsoever:
 - a. install or use more copies of the Software than the number of copies that have been licensed;
 - b. use or install the Software in connection with any product other than the Product the Software was intended to be used or installed on as set out in the documentation that accompanies the Software.
 - c. copy any of the Software or any written materials for any purpose except as part of Licensee's normal backup processes;
 - d. modify or create derivative works based on the Software;
 - e. sub-license, rent, lease, loan or distribute the Software;
 - f. permit any third party to use the Software;
 - g. use or operate Product for the benefit of any third party in any type of service outsourcing, application service, provider service or service bureau capacity;
 - h. reverse engineer, decompile or disassemble the Software or otherwise reduce it to a human perceivable form;
3. **UPDATES.** At Hemisphere's discretion Hemisphere may make Updates available to Licensee. An update ("**Update**") means any update to the Software that is made available to Licensee including error corrections, enhancements and other modifications. Licensee may access, download and install Updates during the Warranty Period only. All Updates that Licensee downloads, installs or uses shall be deemed to be Software and subject to this Agreement. Hemisphere reserves the right to modify the Product without any obligation to notify, supply or install any improvements or alterations to existing Software.
4. **SUPPORT.** Hemisphere may make available directly or through its authorized dealers telephone and email support for the Software. Contact Hemisphere to find the authorized dealer near you. As well, Hemisphere may make available user and technical documentation regarding the Software. Hemisphere reserves the right to reduce and limit access to such support at any time.
5. **BACKUPS AND RECOVERY.** Licensee shall back-up all data used, created or stored by the Software on a regular basis as necessary to enable proper recovery of the data and related systems and processes in the event of a malfunction in the Software or any loss or corruption of data caused by the Software. Licensee shall assume all risks of loss or damage for any failure to comply with the foregoing.
6. **OWNERSHIP.** Hemisphere and its suppliers own all rights, title and interest in and to the Software and related materials, including all intellectual property rights. The Software is licensed to Licensee, not sold.
7. **TRADEMARKS.** "Hemisphere"; "Hemisphere GPS"; "Hemisphere GNSS"; "Crescent"; "Eclipse" and the associated logos are trademarks of Hemisphere. Other trademarks are the property of their respective owners. Licensee may not use any of these trademarks without the consent of their respective owners.
8. **LIMITED WARRANTY.** Hemisphere warrants solely to the Licensee, subject to the exclusions and procedures set forth herein below, that for a period of one (1) year from the original date of purchase of the Product in which it is embedded (the "Warranty Period"), the Software, under normal use and maintenance, will conform in all material respects to the documentation provided with the Software and any media will be free of defects in materials and workmanship. For any Update, Hemisphere warrants, for 90 days from performance or delivery, or for the balance of the original Warranty Period, whichever is greater, that the Update, under normal use and maintenance, will conform in all material respects to the documentation provided with the Update and any media will be free of defects in materials and workmanship. Notwithstanding the foregoing, Hemisphere does not warrant that the Software will meet Licensee's requirements or that its operation will be error free.
9. **WARRANTY EXCLUSIONS.** The warranty set forth in Section (8) will not apply to any deficiencies caused by (a) the Product not being used as described in the documentation supplied to Licensee, (b) the Software having been altered, modified or converted in any way by anyone other than Hemisphere approved by Hemisphere, (c) any malfunction of Licensee's equipment or other software, or (d) damage occurring in transit or due to any accident, abuse, misuse, improper installation, lightning (or other electrical discharge) or neglect other than that caused by Hemisphere. Hemisphere does not warrant or guarantee the precision or accuracy of positions obtained when using the Software (whether standalone or embedded in a Product). The Product and the Software is not intended and should not be used as the primary means of navigation or for use in safety of life applications. The potential

positioning and navigation accuracy obtainable with the Software as stated in the Product or Software documentation serves to provide only an estimate of achievable accuracy based on specifications provided by the US Department of Defense for GPS positioning and DGPS service provider performance specifications, where applicable.

10. **WARRANTY DISCLAIMER.** EXCEPT AS EXPRESSLY SET OUT IN THIS AGREEMENT, HEMISPHERE MAKES NO REPRESENTATION, WARRANTY OR CONDITION OF ANY KIND TO LICENSEE, WHETHER VERBAL OR WRITTEN AND HEREBY DISCLAIMS ALL REPRESENTATIONS, WARRANTIES AND CONDITIONS OF ANY KIND INCLUDING FITNESS FOR A PARTICULAR PURPOSE, MERCHANTABILITY, ACCURACY, RELIABILITY OR THAT THE USE OF THE SOFTWARE WILL BE UNINTERRUPTED OR ERROR-FREE AND HEREBY DISCLAIMS ALL REPRESENTATIONS, WARRANTIES AND CONDITIONS ARISING AS A RESULT OF CUSTOM, USAGE OR TRADE AND THOSE ARISING UNDER STATUTE.
11. **LIMITS ON WARRANTY DISCLAIMER.** Some jurisdictions do not allow the exclusion of implied warranties or conditions, so some of the above exclusions may not apply to Licensee. In that case, any implied warranties or conditions which would then otherwise arise will be limited in duration to ninety (90) days from the date of the license of the Software or the purchase of the Product. The warranties given herein give Licensee specific legal rights and Licensee may have other rights which may vary from jurisdiction to jurisdiction.
12. **CHANGE TO WARRANTY.** No employee or agent of Hemisphere is authorized to change the warranty provided or the limitation or disclaimer of warranty provisions. All such changes will only be effective if pursuant to a separate agreement signed by senior officers of the respective parties.
13. **WARRANTY CLAIM.** In the event Licensee has a warranty claim Licensee must first check for and install all Updates that are made available. The warranty will not otherwise be honored. Proof of purchase may be required. Hemisphere does not honor claims asserted after the end of the Warranty Period.
14. **LICENSEE REMEDIES.** In all cases which involve a failure of the Software to conform in any material respect to the documentation during the Warranty Period or a breach of a warranty, Hemisphere's sole obligation and liability, and Licensee's sole and exclusive remedy, is for Hemisphere, at Hemisphere's option, to (a) repair the Software, (b) replace the Software with software conforming to the documentation, or (c) if Hemisphere is unable, on a reasonable commercial basis, to repair the Software or to replace the Software with conforming software within ninety (90) days, to terminate this Agreement and thereafter Licensee shall cease using the Software. Hemisphere will also issue a refund for the price paid by Licensee less an amount on account of amortization, calculated on a straight-line basis over a deemed useful life of three (3) years.
15. **LIMITATION OF LIABILITY.** IN NO EVENT WILL HEMISPHERE BE LIABLE TO LICENSEE FOR ANY INCIDENTAL, CONSEQUENTIAL, SPECIAL OR INDIRECT DAMAGES INCLUDING ARISING IN RELATION TO ANY LOSS OF DATA, INCOME, REVENUE, GOODWILL OR ANTICIPATED SAVINGS EVEN IF HEMISPHERE HAS BEEN INFORMED OF THE POSSIBILITY OF SUCH LOSS OR DAMAGE. FURTHER, IN NO EVENT WILL HEMISPHERE'S TOTAL CUMULATIVE LIABILITY HEREUNDER, FROM ALL CAUSES OF ACTION OF ANY KIND, EXCEED THE TOTAL AMOUNT PAID BY LICENSEE TO HEMISPHERE TO PURCHASE THE PRODUCT. THIS LIMITATION AND EXCLUSION APPLIES IRRESPECTIVE OF THE CAUSE OF ACTION, INCLUDING BUT NOT LIMITED TO BREACH OF CONTRACT, NEGLIGENCE, STRICT LIABILITY, TORT, BREACH OF WARRANTY, MISREPRESENTATION OR ANY OTHER LEGAL THEORY AND WILL SURVIVE A FUNDAMENTAL BREACH.
16. **LIMITS ON LIMITATION OF LIABILITY.** Some jurisdictions do not allow for the limitation or exclusion of liability for incidental or consequential damages, so the above limitation or exclusion may not apply to Licensee and Licensee may also have other legal rights which may vary from jurisdiction to jurisdiction.
17. **BASIS OF BARGAIN.** Licensee agrees and acknowledges that Hemisphere has set its prices and the parties have entered into this Agreement in reliance on the limited warranties, warranty disclaimers and limitations of liability set forth herein, that the same reflect an agreed-to allocation of risk between the parties (including the risk that a remedy may fail of its essential purpose and cause consequential loss), and that the same forms an essential basis of the bargain between the parties. Licensee agrees and acknowledges that Hemisphere would not have been able to sell the Product at the amount charged on an economic basis without such limitations.
18. **PROPRIETARY RIGHTS INDEMNITY.** Hemisphere shall indemnify, defend and hold harmless Licensee from and against any and all actions, claims, demands, proceedings, liabilities, direct damages, judgments, settlements, fines, penalties, costs and expenses, including royalties and attorneys' fees and related costs, in connection with or arising out of any actual infringement of any third party patent, copyright or other intellectual property right by the Software or by its use, in accordance with this Agreement and documentation, PROVIDED THAT: (a) Hemisphere has the right to assume full control over any action, claim, demand or proceeding, (b) Licensee shall promptly notify Hemisphere of any such action, claim, demand, or proceeding, and (c) Licensee shall give Hemisphere such reasonable assistance and tangible material as is reasonably available to Licensee for the defense of the action, claim, demand or proceeding. Licensee shall not settle or compromise any of same for which Hemisphere has agreed to assume responsibility without Hemisphere's prior written consent. Licensee may, at its sole cost and expense, retain separate counsel from the counsel utilized or retained by Hemisphere.
19. **INFRINGEMENT.** If use of the Software may be enjoined due to a claim of infringement by a third party then, at its sole discretion and expense, Hemisphere may do one of the following: (a) negotiate a license or other agreement so that the Product is no longer subject to such a potential claim, (b) modify the Product so that it becomes non-infringing, provided such modification can be accomplished without materially affecting the performance and functionality of the Product, (c) replace the Software, or the Product, with non-infringing software, or product, of equal or better performance and quality, or (d) if none of the foregoing can be done on a commercially reasonable basis, terminate this license and Licensee shall stop using the Product and Hemisphere shall refund the price paid by Licensee less an amount on account of amortization, calculated on a straight-line basis over a deemed useful life of three (3) years.
The foregoing sets out the entire liability of Hemisphere and the sole obligations of Hemisphere to Licensee in respect of any claim that the Software or its use infringes any third party rights.
20. **INDEMNIFICATION.** Except in relation to an infringement action, Licensee shall indemnify and hold Hemisphere harmless from any and all claims, damages, losses, liabilities, costs and expenses (including reasonable fees of lawyers and other professionals) arising out of or in connection with Licensee's use of the Product, whether direct or indirect, including without limiting the foregoing, loss of data, loss of profit or business interruption.

21. **TERMINATION.** Licensee may terminate this Agreement at any time without cause. Hemisphere may terminate this Agreement on 30 days notice to Licensee if Licensee fails to materially comply with each provision of this Agreement unless such default is cured within the 30 days. Any such termination by a party shall be in addition to and without prejudice to such rights and remedies as may be available, including injunction and other equitable remedies. Upon receipt by Licensee of written notice of termination from Hemisphere or termination by Licensee, Licensee shall at the end of any notice period (a) cease using the Software; and (b) return to Hemisphere (or destroy and provide a certificate of a Senior Officer attesting to such destruction) the Software and all related material and any magnetic or optical media provided to Licensee. The provisions of Sections 6), 7), 8), 9), 10), 15), 21), 26) and 27) herein shall survive the expiration or termination of this Agreement for any reason.
22. **EXPORT RESTRICTIONS.** Licensee agrees that Licensee will comply with all export control legislation of Canada, the United States, Australia and any other applicable country's laws and regulations, whether under the Arms Export Control Act, the International Traffic in Arms Regulations, the Export Administration Regulations, the regulations of the United States Departments of Commerce, State, and Treasury, or otherwise as well as the export control legislation of all other countries.
23. **PRODUCT COMPONENTS.** The Product may contain third party components. Those third party components may be subject to additional terms and conditions. Licensee is required to agree to those terms and conditions in order to use the Product.
24. **FORCE MAJEURE EVENT.** Neither party will have the right to claim damages as a result of the other's inability to perform or any delay in performance due to unforeseeable circumstances beyond its reasonable control, such as labor disputes, strikes, lockouts, war, riot, insurrection, epidemic, Internet virus attack, Internet failure, supplier failure, act of God, or governmental action not the fault of the non-performing party.
25. **FORUM FOR DISPUTES.** The parties agree that the courts located in the State of Arizona and the courts of appeal there from will have exclusive jurisdiction to resolve any disputes between Licensee and Hemisphere concerning this Agreement or Licensee's use or inability to use the Software and the parties hereby irrevocably agree to attorn to the jurisdiction of those courts. Notwithstanding the foregoing, either party may apply to any court of competent jurisdiction for injunctive relief.
26. **APPLICABLE LAW.** This Agreement shall be governed by the laws of the State of Arizona, exclusive of any of its choice of law and conflicts of law jurisprudence.
27. **CISG.** The United Nations Convention on Contracts for the International Sale of Goods will not apply to this Agreement or any transaction hereunder.
28. **GENERAL.** This is the entire agreement between Licensee and Hemisphere relating to the Product and Licensee's use of the same, and supersedes all prior, collateral or contemporaneous oral or written representations, warranties or agreements regarding the same. No amendment to or modification of this Agreement will be binding unless in writing and signed by duly authorized representatives of the parties. Any and all terms and conditions set out in any correspondence between the parties or set out in a purchase order which are different from or in addition to the terms and conditions set forth herein, shall have no application and no written notice of same shall be required. In the event that one or more of the provisions of this Agreement is found to be illegal or unenforceable, this Agreement shall not be rendered inoperative but the remaining provisions shall continue in full force and effect.

Warranty Notice

COVERED PRODUCTS: This warranty covers all products manufactured by Hemisphere GNSS and purchased by the end purchaser (the "Products"), unless otherwise specifically and expressly agreed in writing by Hemisphere GNSS.

LIMITED WARRANTY: Hemisphere GNSS warrants solely to the end purchaser of the Products, subject to the exclusions and procedures set forth below, that the Products sold to such end purchaser and its internal components shall be free, under normal use and maintenance, from defects in materials, and workmanship and will substantially conform to Hemisphere GNSS' applicable specifications for the Product, for a period of 12 months from delivery of such Product to such end purchaser (the "Warranty Period"). Repairs and replacement components for the Products are warranted, subject to the exclusions and procedures set forth below, to be free, under normal use and maintenance, from defects in material and workmanship, and will substantially conform to Hemisphere GNSS' applicable specifications for the Product, for 90 days from performance or delivery, or for the balance of the original Warranty Period, whichever is greater.

EXCLUSION OF ALL OTHER WARRANTIES. The LIMITED WARRANTY shall apply only if the Product is properly and correctly installed, configured, interfaced, maintained, stored, and operated in accordance with Hemisphere GNSS' relevant User's Manual and Specifications, AND the Product is not modified or misused. The Product is provided "AS IS" and the implied warranties of MERCHANTABILITY and FITNESS FOR A PARTICULAR PURPOSE and ALL OTHER WARRANTIES, express, implied or arising by statute, by course of dealing or by trade usage, in connection with the design, sale, installation, service or use of any products or any component thereof, are EXCLUDED from this transaction and shall not apply to the Product. The LIMITED WARRANTY is IN LIEU OF any other warranty, express or implied, including but not limited to, any warranty of MERCHANTABILITY or FITNESS FOR A PARTICULAR PURPOSE, title, and non-infringement.

LIMITATION OF REMEDIES. The purchaser's EXCLUSIVE REMEDY against Hemisphere GNSS shall be, at Hemisphere GNSS' option, the repair or replacement of any defective Product or components thereof. The purchaser shall notify Hemisphere GNSS or a Hemisphere GNSS' approved service center immediately of any defect. Repairs shall be made through a Hemisphere GNSS approved service center only. Repair, modification or service of Hemisphere GNSS products by any party other than a Hemisphere GNSS approved service center shall render this warranty null and void. The remedy in this paragraph shall only be applied in the event that the Product is properly and correctly installed, configured, interfaced, maintained, stored, and operated in accordance with Hemisphere GNSS' relevant User's Manual and Specifications, AND the Product is not modified or misused. NO OTHER REMEDY (INCLUDING, BUT NOT LIMITED TO, SPECIAL, INDIRECT, INCIDENTAL, CONSEQUENTIAL OR CONTINGENT DAMAGES FOR LOST PROFITS, LOST SALES, INJURY TO PERSON OR PROPERTY, OR ANY OTHER INCIDENTAL OR CONSEQUENTIAL LOSS) SHALL BE AVAILABLE TO PURCHASER, even if Hemisphere GNSS has been advised of the possibility of such damages. Without limiting the foregoing, Hemisphere GNSS shall not be liable for any damages of any kind resulting from installation, use, quality, performance or accuracy of any Product.

HEMISPHERE IS NOT RESPONSIBLE FOR PURCHASER'S NEGLIGENCE OR UNAUTHORIZED USES OF THE PRODUCT. IN NO EVENT SHALL HEMISPHERE GNSS BE IN ANY WAY RESPONSIBLE FOR ANY DAMAGES RESULTING FROM PURCHASER'S OWN NEGLIGENCE, OR FROM OPERATION OF THE PRODUCT IN ANY WAY OTHER THAN AS SPECIFIED IN HEMISPHERE GNSS' RELEVANT USER'S MANUAL AND SPECIFICATIONS. Hemisphere GNSS is NOT RESPONSIBLE for defects or performance problems resulting from (1) misuse, abuse, improper installation, neglect of Product; (2) the utilization of the Product with hardware or software products, information, data, systems, interfaces or devices not made, supplied or specified by Hemisphere GNSS; (3) the operation of the Product under any specification other than, or in addition to, the specifications set forth in Hemisphere GNSS' relevant User's Manual and Specifications; (4) damage caused by accident or natural events, such as lightning (or other electrical discharge) or fresh/salt water immersion of Product; (5) damage occurring in transit; (6) normal wear and tear; or (7) the operation or failure of operation of any satellite-based positioning system or differential correction service; or the availability or performance of any satellite-based positioning signal or differential correction signal.

THE PURCHASER IS RESPONSIBLE FOR OPERATING THE VEHICLE SAFELY. The purchaser is solely responsible for the safe operation of the vehicle used in connection with the Product, and for maintaining proper system control settings. UNSAFE DRIVING OR SYSTEM CONTROL SETTINGS CAN RESULT IN PROPERTY DAMAGE, INJURY, OR DEATH. The purchaser is solely responsible for his/her safety and for the safety of others. The purchaser is solely responsible for maintaining control of the automated steering system at all times. THE PURCHASER IS SOLELY RESPONSIBLE FOR ENSURING THE PRODUCT IS PROPERLY AND CORRECTLY INSTALLED, CONFIGURED, INTERFACED, MAINTAINED, STORED, AND OPERATED IN ACCORDANCE WITH HEMISPHERE GNSS' RELEVANT USER'S MANUAL AND SPECIFICATIONS. Hemisphere GNSS does not warrant or guarantee the positioning and navigation precision or accuracy obtained when using Products. Products are not intended for primary navigation or for use in safety of life applications. The potential accuracy of Products as stated in Hemisphere GNSS literature and/or Product specifications serves to provide only an estimate of achievable accuracy based on performance specifications provided by the satellite service operator (i.e. US Department of Defense in the case of GNSS) and differential correction service provider. Hemisphere GNSS reserves the right to modify Products without any obligation to notify, supply or install any improvements or alterations to existing Products.

GOVERNING LAW. This agreement and any disputes relating to, concerning or based upon the Product shall be governed by and interpreted in accordance with the laws of the State of Arizona.

OBTAINING WARRANTY SERVICE. In order to obtain warranty service, the end purchaser must bring the Product to a Hemisphere GNSS approved service center along with the end purchaser's proof of purchase. Hemisphere GNSS does not warrant claims asserted after the end of the warranty period. For any questions regarding warranty service or to obtain information regarding the location of any of Hemisphere GNSS approved service center, contact Hemisphere GNSS at the following address:

Hemisphere GNSS

8444 N. 90th Street, Suite 120

Scottsdale, AZ 85258

Phone: 480-348-9919 Fax: 480-348-6370

techsupport@hemispheregps.com



www.hemispheregps.com